

PEFY-P-VMM-E

PEFY-P-VMM-E

1. SPECIFICATIONS	IU-B- 2
2. CAPACITY TABLES	
2-1a. Cooling capacity in combination with PUHY,PUY, PURY-P200, 250YGM	IU-B- 5
2-1b. Heating capacity in combination with PUHY, PURY-P200, 250YGM	IU-B- 7
2-2a. Cooling capacity in combination with PUHY,PUY,PURY-P300,350YGM / PUHY,PURY-P400YGM	IU-B- 8
2-2b. Heating capacity in combination with PUHY, PURY-P300, 350, 400YGM	IU-B- 10
2-3a. Cooling capacity in combination with PUHY,PURY-P450, 500, 550, 600, 650YGM	IU-B- 11
2-3b. Heating capacity in combination with PUHY,PURY-P450, 500, 550, 600, 650YGM	IU-B- 13
2-4a. Cooling capacity in combination with PQHY,PQRY-P200,250YGM, PQHY,PQRY-P400,500YSGM	IU-B- 14
2-4b. Heating capacity in combination with PQHY,PQRY-P200,250YGM, PQHY,PQRY-P400,500YSGM	IU-B- 15
2-5a. Cooling capacity in combination with PUMY-P100,125,140YHM	IU-B- 16
2-5b. Heating capacity in combination with PUMY-P100,125,140YHM	IU-B- 18
3. SOUND LEVELS	
3-1. Sound levels	IU-B- 19
3-2. NC curves	IU-B- 19
3-3. Fan characteristics curves	IU-B- 24
4. EXTERNAL DIMENSIONS	IU-B- 26
5. ELECTRICAL WIRING DIAGRAMS	IU-B- 31
6. Optional parts for PEFY-P-VMM-E	IU-B- 33

- A
- B**
- C
- D
- E
- F
- G
- H
- I
- J
- V₄
- V₅
- BC

Ceiling concealed	P20	P25	P32	P40	P50	P63	P71	P80	P100	P125	P140	P200	P250
	0.8HP	1.0HP	1.3HP	1.6HP	2.0HP	2.5HP	2.8HP	3.2HP	4.0HP	5.0HP	5.6HP	8.0HP	10.0HP
PEFY-P-VMM-E	●	●	●	●	●	●	●	●	●	●	●		

1. SPECIFICATIONS

R410A Data G2

Model			PEFY-P20VMM-E	PEFY-P25VMM-E	PEFY-P32VMM-E	PEFY-P40VMM-E	
Power source			1-phase 220-240V 50Hz				
Cooling capacity (Nominal)	*1	kW	2.2	2.8	3.6	4.5	
		kcal / h	1,900	2,400	3,100	3,900	
		Btu / h	7,500	9,600	12,300	15,400	
	*2	kcal / h	2,000	2,500	3,150	4,000	
		Power input	kW	0.15	0.15	0.17	0.19
		Current input	A	0.73	0.73	0.81	0.92
Heating capacity (Nominal)	*3	kW	2.5	3.2	4.0	5.0	
		kcal / h	2,200	2,800	3,400	4,300	
		Btu / h	8,500	10,900	13,600	17,100	
	Power input	kW	0.15	0.15	0.17	0.19	
		Current input	A	0.73	0.73	0.81	0.92
External finish			Galvanized				
External dimension H x W x D		mm	295 x 815 x 700	295x815x700	295x815x700	295x935x700	
		in.	11-5/8" x 32-1/8" x 27-9/16"	11-5/8" x 32-1/8" x 27-9/16"	11-5/8" x 32-1/8" x 27-9/16"	11-5/8" x 36-13/16" x 27-9/16"	
Net weight		kg (lb)	27 (60)	27 (60)	27 (60)	33 (73)	
Heat exchanger			Cross fin (Aluminum fin and copper tube)				
FAN	Type x Quantity		Sirocco fan x 1	Sirocco fan x 1	Sirocco fan x 1	Sirocco fan x 2	
	External static press.	Pa	30- 50- 100	30- 50- 100	30- 50- 100	30- 50- 100	
		mmH ₂ O	3.1- 5.1- 10.2	3.1- 5.1- 10.2	3.1- 5.1- 10.2	3.1- 5.1- 10.2	
	Motor type		1-phase induction motor				
	Motor output		kW	0.075	0.075	0.075	0.075
	Driving mechanism		Direct-driven by motor				
	Airflow rate (Low-Mid-High)	m ³ / min	6.0 - 7.2 - 8.5	6.0 - 7.2 - 8.5	7.5-9.0-10.5	10.0-12.0-14.0	
		L / s	100 - 120 - 142	100 - 120 - 142	125-150-175	167-200-233	
cfm		212 - 254 - 300	212 - 254 - 300	265-318-371	353-424-494		
Noise level (Low-Mid-High) (measured in anechoic room)		dB <A>	27-30-32	27-30-32	28-32-35	31-34-37	
Insulation material			Polyethylene foam, Urethane foam				
Air filter			PP honeycomb fabric (washable)				
Protection device			Fuse				
Refrigerant control device			LEV				
Connectable outdoor unit			R410A, R407C, R22 CITY MULTI				
Diameter of refrigerant pipe	Liquid (R410A) (R22, R407C)	mm (in.)	ø6.35 (ø1/4") Flare	ø6.35 (ø1/4") Flare	ø6.35 (ø1/4") Flare	ø6.35 (ø1/4") Flare	
			ø6.35 (ø1/4") Flare	ø6.35 (ø1/4") Flare	ø6.35 (ø1/4") Flare	ø6.35 (ø1/4") Flare	
	Gas (R410A) (R22, R407C)	mm (in.)	ø12.7 (ø1/2") Flare	ø12.7 (ø1/2") Flare	ø12.7 (ø1/2") Flare	ø12.7 (ø1/2") Flare	
		mm (in.)	ø12.7 (ø1/2") Flare	ø12.7 (ø1/2") Flare	ø12.7 (ø1/2") Flare	ø12.7 (ø1/2") Flare	
Diameter of drain pipe		mm (in.)	R1(External thread)	R1(External thread)	R1(External thread)	R1(External thread)	
Drawing	External		IU - W65-3948				
	Wiring		IU - W65-3958				
	Refrigerant cycle		-				
Standard attachment	Document		Installation Manual, Instruction Book				
	Accessory		Drain hose VP-25 (flexible joint)				
Remark	Optional parts						
	Circular duct flange		PAC-KE32EDF-F	PAC-KE32EDF-F	PAC-KE32EDF-F	PAC-KE50EDF-F	
	Drain pump kit		PAC-KE03DM-F	PAC-KE03DM-F	PAC-KE03DM-F	PAC-KE03DM-F	
	Installation		Details on foundation work, duct work, insulation work, electrical wiring, power source switch, and other items shall be referred to				
Note :			*:1 Nominal cooling conditions	*:2 Nominal cooling conditions	*:3 Nominal heating conditions	Unit converter	
Indoor :			27°CDB/19°CWB (81°FDB/66°FWB)	27°CDB/19.5°CWB (81°FDB/67°FWB)	20°CDB (68°FDB)	kcal/h = kW x 860	
Outdoor :			35°CDB (95°FDB)	35°CDB (95°FDB)	7°CDB/6°CWB (45°FDB/43°FWB)	Btu/h = kW x 3,412	
Pipe length :			7.5 m (24-9/16 ft)	5 m (16-3/8 ft)	7.5 m (24-9/16 ft)	cfm = m ³ /min x 35.31	
Level difference :			0 m (0 ft)	0 m (0 ft)	0 m (0 ft)	lb = kg / 0.4536	
* Nominal conditions *:1, *:3 are subject to JIS B8615-1.						*Above specification data is subject to rounding variation.	
* Due to continuing improvement, above specification may be subject to change without notice.						Ref.: Spec_PEFY-P-VMM-E_1	

1. SPECIFICATIONS

Model			PEFY-P50VMM-E	PEFY-P63VMM-E	PEFY-P71VMM-E	PEFY-P80VMM-E	
Power source			1-phase 220-240V 50Hz				
Cooling capacity (Nominal)	*1	kW	5.6	7.1	8.0	9.0	
		kcal / h	4,800	6,100	6,900	7,700	
		Btu / h	19,100	24,200	27,300	30,700	
	*2	kcal / h	5,000	6,300	7,100	8,000	
		Power input kW	0.2	0.22	0.25	0.25	
Current input A		0.98	1.07	1.15	1.15		
Heating capacity (Nominal)	*3	kW	6.3	8.0	9.0	10.0	
		kcal / h	5,400	6,900	7,700	8,600	
		Btu / h	21,500	27,300	30,700	34,100	
	Power input kW	0.2	0.22	0.25	0.25		
		Current input A		0.98	1.07	1.15	1.15
External finish			Galvanized				
External dimension H x W x D		mm	295 x 935 x 700	295 x 1,175 x 700	295 x 1,175 x 700	295 x 1,175 x 700	
		in.	11-5/8" x 36-13/16" x 27-9/16"	11-5/8" x 46-5/16" x 27-9/16"	11-5/8" x 46-5/16" x 27-9/16"	11-5/8" x 46-5/16" x 27-9/16"	
Net weight		kg (lb)	33 (73)	42 (93)	42 (93)	42 (93)	
Heat exchanger			Cross fin (Aluminum fin and copper tube)				
FAN	Type x Quantity		Sirocco fan x 2	Sirocco fan x 2	Sirocco fan x 2	Sirocco fan x 2	
	External static press.	Pa	30- 50- 100	30- 50- 100	30- 50- 100	30- 50- 100	
		mmH ₂ O	3.1- 5.1- 10.2	3.1- 5.1- 10.2	3.1- 5.1- 10.2	3.1- 5.1- 10.2	
	Motor type			1-phase induction motor			
	Motor output kW		0.075	0.078	0.078	0.078	
	Driving mechanism			Direct-driven by motor			
	Airflow rate (Low-Mid-High)	m ³ / min	12.0-14.5-17.0	13.5-16.2-19.0	14.5-18.0-21.0	14.5-18.0-21.0	
		L / s	200-242-283	225-270-317	242-300-350	242-300-350	
cfm		424-512-600	477-572-671	512-636-742	512-636-742		
Noise level (Low-Mid-High) (measured in anechoic room)		dB <A>	31-35-38	31-35-38	32-36-39	32-36-39	
Insulation material			Polyethylene foam, Urethane foam				
Air filter			PP honeycomb fabric (washable)				
Protection device			Fuse				
Refrigerant control device			LEV				
Connectable outdoor unit			R410A, R407C, R22 CITY MULTI				
Diameter of refrigerant pipe	Liquid (R410A) (R22, R407C)	mm (in.)	ø6.35 (ø1/4") Flare	ø9.52 (ø3/8") Flare	ø9.52 (ø3/8") Flare	ø9.52 (ø3/8") Flare	
			ø9.52 (ø3/8") Flare	ø9.52 (ø3/8") Flare	ø9.52 (ø3/8") Flare	ø9.52 (ø3/8") Flare	
	Gas (R410A) (R22, R407C)	mm (in.)	ø12.7 (ø1/2") Flare	ø15.88 (ø5/8") Flare	ø15.88 (ø5/8") Flare	ø15.88 (ø5/8") Flare	
			ø15.88 (ø5/8") Flare	ø15.88 (ø5/8") Flare	ø15.88 (ø5/8") Flare	ø15.88 (ø5/8") Flare	
Diameter of drain pipe		mm (in.)	R1(External thread)	R1(External thread)	R1(External thread)	R1(External thread)	
Drawing	External		IU - W65-3948				
	Wiring		IU - W65-3958				
	Refrigerant cycle		-				
Standard attachment	Document		Installation Manual, Instruction Book				
	Accessory		Drain hose VP-25 (flexible joint)				
Remark	Optional parts						
	Circular duct flange		PAC-KE50EDF-F	PAC-KE80EDF-F	PAC-KE80EDF-F	PAC-KE80EDF-F	
	Drain pump kit		PAC-KE03DM-F	PAC-KE03DM-F	PAC-KE03DM-F	PAC-KE03DM-F	
	Installation		Details on foundation work, duct work, insulation work, electrical wiring, power source switch, and other items shall be referred to				

Note :	*1 Nominal cooling conditions	*2 Nominal cooling conditions	*3 Nominal heating conditions	Unit converter
	Indoor : 27°CDB/19°CWB (81°FDB/66°FWB)	27°CDB/19.5°CWB (81°FDB/67°FWB)	20°CDB (68°FDB)	kcal/h = kW x 860
	Outdoor : 35°CDB (95°FDB)	35°CDB (95°FDB)	7°CDB/6°CWB (45°FDB/43°FWB)	Btu/h = kW x 3,412
	Pipe length : 7.5 m (24-9/16 ft)	5 m (16-3/8 ft)	7.5 m (24-9/16 ft)	cfm = m ³ /min x 35.31
	Level difference : 0 m (0 ft)	0 m (0 ft)	0 m (0 ft)	lb = kg / 0.4536
* Nominal conditions *1, *3 are subject to JIS B8615-1.				*Above specification data is subject to rounding variation.
* Due to continuing improvement, above specification may be subject to change without notice.				

Ref.: Spec_PEFY-P-VMM-E_2

1. SPECIFICATIONS

R410A Data G2

Model		PEFY-P100VMM-E	PEFY-P125VMM-E	PEFY-P140VMM-E		
Power source		1-phase 220-240V 50Hz				
Cooling capacity (Nominal)	*1	kW	11.2	14.0	16.0	
	*1	kcal / h	9,600	12,000	13,800	
	*1	Btu / h	38,200	47,800	54,600	
	*2	kcal / h	10,000	12,500	14,000	
		Power input	kW	0.29	0.4	0.42
		Current input	A	1.34	1.9	1.95
Heating capacity (Nominal)	*3	kW	12.5	16.0	18.0	
	*3	kcal / h	10,800	13,800	15,500	
	*3	Btu / h	42,700	54,600	61,400	
		Power input	kW	0.29	0.4	0.42
			Current input	A	1.34	1.9
External finish		Galvanized				
External dimension H x W x D		mm	325 x 1,415 x 740	325 x 1,415 x 740	325 x 1,715 x 740	
		in.	12-13/16" x 55-3/4" x 29-3/16"	12-13/16" x 55-3/4" x 29-3/16"	12-13/16" x 67-9/16" x 29-3/16"	
Net weight		kg (lb)	62 (137)	65 (144)	70 (155)	
Heat exchanger		Cross fin (Aluminum fin and copper tube)				
FAN	Type x Quantity		Sirocco fan x 2	Sirocco fan x 2	Sirocco fan x 2	
	External static press.	Pa	50- 130	50- 130	50- 130	
		mmH ₂ O	5.1- 13.3	5.1- 13.3	5.1- 13.3	
	Motor type		1-phase induction motor			
	Motor output		kW	0.200	0.280	0.280
	Driving mechanism		Direct-driven by motor			
	Airflow rate (Low-Mid-High)	m ³ / min		23.0 - 33.0	28.0 - 40.0	29.5 - 42.0
		L / s		383 - 550	467 - 667	492 - 700
cfm		812 - 1,165	989 - 1,413	1,042 - 1,483		
Noise level (Low-Mid-High) (measured in anechoic room)		dB <A>	40 - 44	42 - 45	42 - 45	
Insulation material		Polyethylene foam, Urethane foam				
Air filter		PP honeycomb fabric (washable)				
Protection device		Fuse				
Refrigerant control device		LEV				
Connectable outdoor unit		R410A, R407C, R22 CITY MULTI				
Diameter of refrigerant pipe	Liquid (R410A) (R22, R407C)	mm (in.)	ø9.52 (ø3/8") Flare	ø9.52 (ø3/8") Flare	ø9.52 (ø3/8") Flare	
			ø9.52 (ø3/8") Flare	ø9.52 (ø3/8") Flare	ø9.52 (ø3/8") Flare	
	Gas (R410A) (R22, R407C)	mm (in.)	ø15.88 (ø5/8") Flare	ø15.88 (ø5/8") Flare	ø15.88 (ø5/8") Flare	
			ø19.05 (ø3/4") Flare	ø19.05 (ø3/4") Flare	ø19.05 (ø3/4") Flare	
Diameter of drain pipe		mm (in.)	R1(External thread)	R1(External thread)	R1(External thread)	
Drawing	External		IU - W65-3949	IU - W65-3949	IU - W65-3949	
	Wiring		IU - W65-3959	IU - W65-3959	IU - W65-3959	
	Refrigerant cycle		-	-	-	
Standard attachment		Document Accessory Installation Manual, Instruction Book				
Remark	Optional parts					
	Circular duct flange		PAC-KE125EDF-F	PAC-KE125EDF-F	PAC-KE140EDF-F	
	Drain pump kit		PAC-KE03DM-F	PAC-KE03DM-F	PAC-KE03DM-F	
	Installation		Details on foundation work, duct work, insulation work, electrical wiring, power source switch, and other items shall be referred to			
Note :		*1 Nominal cooling conditions	*2 Nominal cooling conditions	*3 Nominal heating conditions	Unit converter	
Indoor :		27°CDB/19°CWB (81°FDB/66°FWB)	27°CDB/19.5°CWB (81°FDB/67°FWB)	20°CDB (68°FDB)	kcal/h = kW x 860	
Outdoor :		35°CDB (95°FDB)	35°CDB (95°FDB)	7°CDB/6°CWB (45°FDB/43°FWB)	Btu/h = kW x 3,412	
Pipe length :		7.5 m (24-9/16 ft)	5 m (16-3/8 ft)	7.5 m (24-9/16 ft)	cfm = m ³ /min x 35.31	
Level difference :		0 m (0 ft)	0 m (0 ft)	0 m (0 ft)	lb = kg / 0.4536	
* Nominal conditions *1, *3 are subject to JIS B8615-1.					*Above specification data is subject to rounding variation.	
* Due to continuing improvement, above specification may be subject to change without notice.						

Ref.: Spec_PEFY-P-VMM-E_3

2. CAPACITY TABLES

R410A Data G2

2-1a. Cooling capacity in combination with PUHY,PUY,PURY-P200,250YGM

PEFY-P-VMM-E

CA : Capacity(kW) SHC : Sensible Heat Capacity(kW)

Model size (Rated kW)	Outdoor air temp.		Indoor air temp.													
			71°FDB / 59°FWB		73°FDB / 61°FWB		77°FDB / 64°FWB		81°FDB / 66°FWB		82°FDB / 68°FWB		86°FDB / 72°FWB		90°FDB / 75°FWB	
			21.5°CDB / 15°CWB		23°CDB / 16°CWB		25°CDB / 18°CWB		27°CDB / 19°CWB		28°CDB / 20°CWB		30°CDB / 22°CWB		32°CDB / 24°CWB	
	°FDB	°CDB	CA	SHC	CA	SHC	CA	SHC	CA	SHC	CA	SHC	CA	SHC	CA	SHC
80 (9.0)	68	20.0	8.6	6.1	8.9	6.3	9.5	6.2	9.7	6.3	10.0	6.5	10.6	6.4	11.4	6.4
	73	22.5	8.6	6.1	8.9	6.3	9.5	6.2	9.7	6.3	10.0	6.5	10.6	6.4	11.4	6.4
	77	25.0	8.6	6.1	8.9	6.3	9.5	6.2	9.7	6.3	9.9	6.5	10.5	6.4	11.2	6.3
	82	27.5	8.5	6.1	8.8	6.2	9.3	6.2	9.5	6.2	9.8	6.4	10.3	6.3	11.0	6.2
	86	30.0	8.4	6.0	8.6	6.2	9.1	6.1	9.4	6.1	9.6	6.3	10.1	6.2	10.8	6.1
	91	32.5	8.2	5.9	8.5	6.1	8.9	6.0	9.1	6.0	9.4	6.3	9.9	6.1	10.5	6.1
	95	35.0	8.1	5.8	8.3	6.0	8.8	5.9	9.0	6.0	9.2	6.2	9.7	6.1	10.3	6.0
	100	37.5	7.9	5.8	8.1	5.9	8.6	5.8	8.8	5.9	9.0	6.1	9.5	6.0	10.1	5.9
	104	40.0	7.7	5.7	8.0	5.8	8.5	5.8	8.6	5.8	8.9	6.0	9.3	5.9	9.9	5.8
	110	43.0	7.6	5.6	7.8	5.8	8.2	5.7	8.4	5.7	8.6	5.9	9.1	5.8	9.6	5.7
100 (11.2)	68	20.0	10.6	8.3	11.0	8.6	11.8	8.5	12.1	8.7	12.5	9.0	13.2	8.9	14.2	8.8
	73	22.5	10.6	8.3	11.0	8.6	11.8	8.5	12.1	8.7	12.5	9.0	13.2	8.9	14.2	8.8
	77	25.0	10.6	8.3	11.0	8.6	11.8	8.5	12.1	8.7	12.4	9.0	13.1	8.8	13.9	8.7
	82	27.5	10.6	8.3	10.9	8.5	11.5	8.4	11.9	8.6	12.2	8.9	12.8	8.7	13.7	8.6
	86	30.0	10.4	8.2	10.7	8.4	11.3	8.3	11.6	8.5	11.9	8.8	12.5	8.6	13.4	8.5
	91	32.5	10.2	8.1	10.5	8.4	11.1	8.2	11.4	8.4	11.7	8.7	12.3	8.6	13.1	8.4
	95	35.0	10.0	8.0	10.3	8.3	10.9	8.2	11.2	8.3	11.5	8.6	12.1	8.5	12.8	8.3
	100	37.5	9.8	7.9	10.1	8.1	10.7	8.1	10.9	8.2	11.3	8.5	11.9	8.4	12.5	8.3
	104	40.0	9.6	7.8	9.9	8.1	10.5	8.0	10.8	8.1	11.1	8.5	11.6	8.3	12.3	8.2
	110	43.0	9.4	7.7	9.7	8.0	10.2	7.9	10.4	8.0	10.8	8.3	11.3	8.2	12.0	8.1
125 (14.0)	68	20.0	13.3	10.2	13.8	10.5	14.7	10.4	15.1	10.6	15.6	11.0	16.5	10.8	17.7	10.8
	73	22.5	13.3	10.2	13.8	10.5	14.7	10.4	15.1	10.6	15.6	11.0	16.5	10.8	17.7	10.8
	77	25.0	13.3	10.2	13.8	10.5	14.7	10.4	15.1	10.6	15.5	10.9	16.4	10.8	17.4	10.6
	82	27.5	13.2	10.1	13.7	10.4	14.4	10.3	14.8	10.5	15.3	10.9	16.0	10.7	17.1	10.5
	86	30.0	13.0	10.0	13.4	10.3	14.2	10.2	14.6	10.4	14.9	10.7	15.7	10.5	16.7	10.4
	91	32.5	12.7	9.9	13.2	10.2	13.9	10.1	14.2	10.2	14.6	10.6	15.4	10.4	16.4	10.3
	95	35.0	12.5	9.8	12.9	10.1	13.7	10.0	14.0	10.1	14.4	10.5	15.1	10.3	16.0	10.2
	100	37.5	12.3	9.7	12.6	10.0	13.4	9.9	13.7	10.0	14.1	10.4	14.8	10.2	15.7	10.0
	104	40.0	12.0	9.6	12.4	9.9	13.2	9.8	13.4	9.9	13.9	10.3	14.5	10.1	15.4	9.9
	110	43.0	11.8	9.4	12.1	9.7	12.8	9.6	13.0	9.7	13.4	10.1	14.1	10.0	15.0	9.8
140 (16.0)	68	20.0	15.2	11.3	15.8	11.6	16.8	11.6	17.3	11.7	17.8	12.2	18.9	12.0	20.2	11.9
	73	22.5	15.2	11.3	15.8	11.6	16.8	11.6	17.3	11.7	17.8	12.2	18.9	12.0	20.2	11.9
	77	25.0	15.2	11.3	15.8	11.6	16.8	11.6	17.3	11.7	17.7	12.1	18.7	11.9	19.8	11.7
	82	27.5	15.1	11.2	15.6	11.6	16.5	11.4	17.0	11.6	17.4	12.0	18.3	11.8	19.5	11.6
	86	30.0	14.9	11.1	15.3	11.4	16.2	11.3	16.6	11.4	17.0	11.8	17.9	11.6	19.1	11.5
	91	32.5	14.6	11.0	15.0	11.3	15.8	11.1	16.2	11.3	16.7	11.7	17.6	11.5	18.7	11.3
	95	35.0	14.3	10.8	14.7	11.1	15.6	11.0	16.0	11.2	16.4	11.6	17.3	11.4	18.3	11.2
	100	37.5	14.0	10.7	14.4	11.0	15.3	10.9	15.6	11.0	16.1	11.4	17.0	11.2	17.9	11.1
	104	40.0	13.8	10.6	14.2	10.9	15.0	10.8	15.4	10.9	15.8	11.3	16.6	11.1	17.6	10.9
	110	43.0	13.4	10.4	13.8	10.7	14.6	10.6	14.9	10.7	15.4	11.1	16.2	10.9	17.1	10.8

kcal/h = kW x 860, Btu/h = kW x 3,412

2. CAPACITY TABLES

R410A Data G2

2-1b. Heating capacity in combination with PUHY,PURY-P200,250YGM

PEFY-P-VMM-E

SHC : Sensible Heat Capacity(kW)

Model size (Rated kW)	Outdoor air temp.		Indoor air temp.			
			59 °FDB	68 °FDB	77 °FDB	81 °FDB
			15.0°CDB	20.0°CDB	25.0°CDB	27.0°CDB
	°FWB	°CWB	SHC	SHC	SHC	SHC
20 (2.2)	-4	-20.0	1.3	1.3	1.3	1.3
	5	-15.0	1.6	1.5	1.5	1.5
	14	-10.0	1.8	1.8	1.8	1.7
	23	-5.0	2.1	2.1	2.0	1.8
	32	0.0	2.4	2.4	2.0	1.8
	37	2.5	2.5	2.5	2.0	1.8
	43	6.0	2.6	2.5	2.0	1.8
	46	7.5	2.7	2.5	2.0	1.8
	50	10.0	2.9	2.5	2.0	1.8
	55	12.5	3.0	2.5	2.0	1.8
60	15.5	3.2	2.5	2.0	1.8	
25 (2.8)	-4	-20.0	1.6	1.6	1.6	1.6
	5	-15.0	2.0	2.0	1.9	1.9
	14	-10.0	2.3	2.3	2.2	2.2
	23	-5.0	2.7	2.7	2.6	2.2
	32	0.0	3.0	3.0	2.6	2.2
	37	2.5	3.2	3.2	2.6	2.2
	43	6.0	3.3	3.2	2.6	2.2
	46	7.5	3.4	3.2	2.6	2.2
	50	10.0	3.6	3.2	2.6	2.2
	55	12.5	3.9	3.2	2.6	2.2
60	15.5	4.1	3.2	2.6	2.2	
32 (3.6)	-4	-20.0	2.1	2.0	2.0	2.0
	5	-15.0	2.5	2.4	2.4	2.4
	14	-10.0	2.9	2.9	2.8	2.7
	23	-5.0	3.4	3.3	3.2	2.8
	32	0.0	3.8	3.8	3.2	2.8
	37	2.5	4.0	4.0	3.2	2.8
	43	6.0	4.2	4.0	3.2	2.8
	46	7.5	4.3	4.0	3.2	2.8
	50	10.0	4.6	4.0	3.2	2.8
	55	12.5	4.8	4.0	3.2	2.8
60	15.5	5.1	4.0	3.2	2.8	
40 (4.5)	-4	-20.0	2.6	2.5	2.5	2.5
	5	-15.0	3.1	3.1	3.0	3.0
	14	-10.0	3.7	3.6	3.5	3.4
	23	-5.0	4.2	4.2	4.0	3.5
	32	0.0	4.7	4.7	4.0	3.5
	37	2.5	5.0	5.0	4.0	3.5
	43	6.0	5.2	5.0	4.0	3.5
	46	7.5	5.4	5.0	4.0	3.5
	50	10.0	5.7	5.0	4.0	3.5
	55	12.5	6.0	5.0	4.0	3.5
60	15.5	6.4	5.0	4.0	3.5	
50 (5.6)	-4	-20.0	3.2	3.2	3.2	3.2
	5	-15.0	3.9	3.8	3.8	3.7
	14	-10.0	4.6	4.5	4.4	4.3
	23	-5.0	5.3	5.2	5.0	4.4
	32	0.0	6.0	5.9	5.0	4.4
	37	2.5	6.3	6.2	5.0	4.4
	43	6.0	6.6	6.3	5.0	4.4
	46	7.5	6.8	6.3	5.0	4.4
	50	10.0	7.2	6.3	5.0	4.4
	55	12.5	7.6	6.3	5.0	4.4
60	15.5	8.1	6.3	5.0	4.4	
63 (7.1)	-4	-20.0	4.1	4.0	4.0	4.0
	5	-15.0	5.0	4.9	4.8	4.7
	14	-10.0	5.8	5.8	5.6	5.5
	23	-5.0	6.7	6.6	6.4	5.6
	32	0.0	7.6	7.5	6.4	5.6
	37	2.5	8.0	7.9	6.4	5.6
	43	6.0	8.3	8.0	6.4	5.6
	46	7.5	8.6	8.0	6.4	5.6
	50	10.0	9.1	8.0	6.4	5.6
	55	12.5	9.6	8.0	6.4	5.6
60	15.5	10.2	8.0	6.4	5.6	
71 (8.0)	-4	-20.0	4.6	4.5	4.5	4.5
	5	-15.0	5.6	5.5	5.4	5.3
	14	-10.0	6.6	6.5	6.3	6.2
	23	-5.0	7.6	7.5	7.2	6.3
	32	0.0	8.5	8.5	7.2	6.3
	37	2.5	9.0	8.9	7.2	6.3
	43	6.0	9.4	9.0	7.2	6.3
	46	7.5	9.7	9.0	7.2	6.3
	50	10.0	10.3	9.0	7.2	6.3
	55	12.5	10.8	9.0	7.2	6.3
60	15.5	11.5	9.0	7.2	6.3	

Model size (Rated kW)	Outdoor air temp.		Indoor air temp.			
			59 °FDB	68 °FDB	77 °FDB	81 °FDB
			15.0°CDB	20.0°CDB	25.0°CDB	27.0°CDB
	°FWB	°CWB	SHC	SHC	SHC	SHC
80 (9.0)	-4	-20.0	5.2	5.0	5.0	5.0
	5	-15.0	6.2	6.1	6.0	5.9
	14	-10.0	7.3	7.2	7.0	6.9
	23	-5.0	8.4	8.3	8.0	7.0
	32	0.0	9.5	9.4	8.0	7.0
	37	2.5	10.0	9.9	8.0	7.0
	43	6.0	10.4	10.0	8.0	7.0
	46	7.5	10.8	10.0	8.0	7.0
	50	10.0	11.4	10.0	8.0	7.0
	55	12.5	12.1	10.0	8.0	7.0
60	15.5	12.8	10.0	8.0	7.0	
100 (11.2)	-4	-20.0	6.4	6.3	6.3	6.3
	5	-15.0	7.8	7.6	7.5	7.4
	14	-10.0	9.1	9.0	8.8	8.6
	23	-5.0	10.5	10.4	10.0	8.8
	32	0.0	11.8	11.8	10.0	8.8
	37	2.5	12.5	12.4	10.0	8.8
	43	6.0	13.0	12.5	10.0	8.8
	46	7.5	13.4	12.5	10.0	8.8
	50	10.0	14.3	12.5	10.0	8.8
	55	12.5	15.1	12.5	10.0	8.8
60	15.5	16.0	12.5	10.0	8.8	
125 (14.0)	-4	-20.0	8.2	8.0	8.0	8.0
	5	-15.0	9.9	9.8	9.6	9.4
	14	-10.0	11.7	11.5	11.2	11.0
	23	-5.0	13.4	13.3	12.8	11.2
	32	0.0	15.1	15.0	12.8	11.2
	37	2.5	16.0	15.8	12.8	11.2
	43	6.0	16.6	16.0	12.8	11.2
	46	7.5	17.2	16.0	12.8	11.2
	50	10.0	18.2	16.0	12.8	11.2
	55	12.5	19.3	16.0	12.8	11.2
60	15.5	20.5	16.0	12.8	11.2	
140 (16.0)	-4	-20.0	9.3	9.0	9.0	9.0
	5	-15.0	11.2	11.0	10.8	10.6
	14	-10.0	13.1	13.0	12.6	12.3
	23	-5.0	15.1	14.9	14.4	12.6
	32	0.0	17.0	16.9	14.4	12.6
	37	2.5	18.0	17.8	14.4	12.6
	43	6.0	18.7	18.0	14.4	12.6
	46	7.5	19.4	18.0	14.4	12.6
	50	10.0	20.5	18.0	14.4	12.6
	55	12.5	21.7	18.0	14.4	12.6
60	15.5	23.0	18.0	14.4	12.6	

kcal/h = kW x 860, Btu/h = kW x 3,412

2. CAPACITY TABLES

R410A Data G2

2-2a. Cooling capacity in combination with PUHY,PUY,PURY-P300,350YGM / PUHY,PURY-P400YGM

PEFY-P-VMM-E

CA : Capacity(kW) SHC : Sensible Heat Capacity(kW)

Model size (Rated kW)	Outdoor air temp.		Indoor air temp.													
			71°FDB / 59°FWB		73°FDB / 61°FWB		77°FDB / 64°FWB		81°FDB / 66°FWB		82°FDB / 68°FWB		86°FDB / 72°FWB		90°FDB / 75°FWB	
	°FDB	°CDB	21.5°CDB / 15°CWB		23°CDB / 16°CWB		25°CDB / 18°CWB		27°CDB / 19°CWB		28°CDB / 20°CWB		30°CDB / 22°CWB		32°CDB / 24°CWB	
		CA	SHC	CA	SHC	CA	SHC	CA	SHC	CA	SHC	CA	SHC	CA	SHC	
80 (9.0)	68	20.0	8.7	6.2	9.0	6.4	9.7	6.4	10.1	6.5	10.4	6.7	11.0	6.6	11.7	6.5
	73	22.5	8.7	6.2	9.0	6.4	9.6	6.3	9.9	6.4	10.2	6.6	10.8	6.5	11.5	6.4
	77	25.0	8.6	6.1	8.8	6.3	9.4	6.2	9.7	6.3	10.0	6.5	10.6	6.4	11.3	6.3
	82	27.5	8.4	6.0	8.6	6.2	9.2	6.1	9.5	6.2	9.8	6.5	10.4	6.4	11.0	6.3
	86	30.0	8.3	6.0	8.5	6.1	9.0	6.1	9.4	6.1	9.6	6.4	10.3	6.3	10.8	6.2
	91	32.5	8.1	5.9	8.3	6.0	8.9	6.0	9.2	6.1	9.5	6.3	10.0	6.2	10.6	6.1
	95	35.0	8.0	5.8	8.1	5.9	8.6	5.9	9.0	6.0	9.3	6.2	9.8	6.1	10.4	6.0
	100	37.5	7.9	5.8	8.0	5.8	8.5	5.8	8.8	5.9	9.1	6.1	9.6	6.0	10.2	5.9
	104	40.0	7.8	5.7	7.8	5.8	8.3	5.7	8.6	5.8	9.8	6.4	9.4	6.0	9.9	5.8
	110	43.0	7.6	5.6	7.6	5.6	8.1	5.6	8.4	5.7	8.6	5.9	9.1	5.8	9.7	5.8
100 (11.2)	68	20.0	10.9	8.4	11.3	8.7	12.1	8.7	12.5	8.8	12.9	9.2	13.7	9.1	14.6	8.9
	73	22.5	10.8	8.4	11.2	8.7	11.9	8.6	12.3	8.8	12.7	9.1	13.5	9.0	14.3	8.8
	77	25.0	10.7	8.3	11.0	8.6	11.7	8.5	12.1	8.7	12.5	9.0	13.2	8.9	14.0	8.7
	82	27.5	10.5	8.2	10.8	8.5	11.5	8.4	11.9	8.6	12.2	8.9	13.0	8.8	13.7	8.7
	86	30.0	10.3	8.1	10.5	8.4	11.3	8.3	11.6	8.5	12.0	8.8	12.8	8.7	13.4	8.6
	91	32.5	10.1	8.1	10.4	8.3	11.0	8.2	11.4	8.4	11.8	8.7	12.4	8.6	13.2	8.5
	95	35.0	10.0	8.0	10.1	8.2	10.8	8.1	11.2	8.3	11.5	8.6	12.2	8.5	12.9	8.4
	100	37.5	9.9	7.9	9.9	8.1	10.6	8.0	10.9	8.2	11.3	8.5	12.0	8.4	12.7	8.3
	104	40.0	9.7	7.8	9.7	8.0	10.4	7.9	10.7	8.1	12.2	8.9	11.7	8.3	12.4	8.2
	110	43.0	9.4	7.7	9.4	7.8	10.1	7.8	10.4	8.0	10.7	8.3	11.4	8.2	12.0	8.1
125 (14.0)	68	20.0	13.6	10.3	14.1	10.6	15.1	10.6	15.7	10.8	16.2	11.2	17.2	11.1	18.2	10.9
	73	22.5	13.5	10.3	14.0	10.6	14.9	10.5	15.4	10.7	15.9	11.1	16.8	11.0	17.9	10.8
	77	25.0	13.4	10.2	13.7	10.5	14.6	10.4	15.1	10.6	15.6	11.0	16.5	10.8	17.5	10.7
	82	27.5	13.1	10.1	13.4	10.3	14.4	10.3	14.8	10.5	15.3	10.9	16.2	10.7	17.2	10.6
	86	30.0	12.9	10.0	13.2	10.2	14.1	10.2	14.6	10.4	15.0	10.7	16.0	10.6	16.8	10.4
	91	32.5	12.7	9.9	13.0	10.1	13.8	10.0	14.3	10.2	14.7	10.6	15.5	10.5	16.5	10.3
	95	35.0	12.5	9.8	12.7	10.0	13.4	9.9	14.0	10.1	14.4	10.5	15.3	10.4	16.2	10.2
	100	37.5	12.3	9.7	12.4	9.9	13.2	9.8	13.7	10.0	14.1	10.4	15.0	10.3	15.8	10.1
	104	40.0	12.1	9.6	12.1	9.7	13.0	9.7	13.4	9.9	15.2	10.8	14.6	10.1	15.5	10.0
	110	43.0	11.8	9.4	11.8	9.6	12.6	9.5	13.0	9.7	13.4	10.1	14.2	10.0	15.1	9.8
140 (16.0)	68	20.0	15.5	11.4	16.1	11.8	17.3	11.8	17.9	12.0	18.5	12.4	19.6	12.3	20.8	12.1
	73	22.5	15.4	11.4	16.0	11.8	17.0	11.7	17.6	11.8	18.2	12.3	19.2	12.1	20.4	11.9
	77	25.0	15.3	11.3	15.7	11.6	16.7	11.5	17.3	11.7	17.8	12.1	18.9	12.0	20.0	11.8
	82	27.5	15.0	11.2	15.4	11.5	16.4	11.4	17.0	11.6	17.5	12.0	18.5	11.8	19.6	11.6
	86	30.0	14.7	11.0	15.0	11.3	16.1	11.2	16.6	11.4	17.1	11.9	18.2	11.7	19.2	11.5
	91	32.5	14.5	10.9	14.8	11.2	15.8	11.1	16.3	11.3	16.8	11.7	17.8	11.5	18.8	11.4
	95	35.0	14.2	10.8	14.5	11.0	15.4	10.9	16.0	11.2	16.5	11.6	17.4	11.4	18.5	11.2
	100	37.5	14.1	10.7	14.2	10.9	15.1	10.8	15.6	11.0	16.2	11.5	17.1	11.3	18.1	11.1
	104	40.0	13.8	10.6	13.8	10.7	14.8	10.7	15.3	10.9	17.4	12.0	16.7	11.2	17.7	11.0
	110	43.0	13.4	10.4	13.4	10.5	14.4	10.5	14.9	10.7	15.3	11.1	16.2	11.0	17.2	10.8

kcal/h = kW x 860, Btu/h = kW x 3,412

2. CAPACITY TABLES

R410A Data G2

2-2b. Heating capacity in combination with PUHY,PURY-P300,350,400YGM

PEFY-P-VMM-E

SHC : Sensible Heat Capacity(kW)

Model size (Rated kW)	Outdoor air temp.		Indoor air temp.			
			59 °FDB	68 °FDB	77 °FDB	81 °FDB
			15.0°CDB	20.0°CDB	25.0°CDB	27.0°CDB
	°FWB	°CWB	SHC	SHC	SHC	SHC
20 (2.2)	-4	-20.0	1.3	1.3	1.3	1.2
	5	-15.0	1.5	1.5	1.5	1.5
	14	-10.0	1.8	1.8	1.7	1.6
	23	-5.0	2.0	2.0	1.9	1.6
	32	0.0	2.3	2.3	1.9	1.6
	37	2.5	2.4	2.4	1.9	1.6
	43	6.0	2.6	2.5	1.9	1.6
	46	7.5	2.7	2.5	1.9	1.6
	50	10.0	2.8	2.5	1.9	1.6
	55	12.5	2.9	2.5	1.9	1.6
60	15.5	2.9	2.5	1.9	1.6	
25 (2.8)	-4	-20.0	1.7	1.6	1.6	1.5
	5	-15.0	1.9	1.9	1.9	1.9
	14	-10.0	2.2	2.2	2.2	2.0
	23	-5.0	2.6	2.6	2.4	2.0
	32	0.0	2.9	2.9	2.4	2.0
	37	2.5	3.1	3.0	2.4	2.0
	43	6.0	3.3	3.2	2.4	2.0
	46	7.5	3.4	3.2	2.4	2.0
	50	10.0	3.5	3.2	2.4	2.0
	55	12.5	3.7	3.2	2.4	2.0
60	15.5	3.7	3.2	2.4	2.0	
32 (3.6)	-4	-20.0	2.1	2.0	2.0	1.9
	5	-15.0	2.4	2.4	2.4	2.3
	14	-10.0	2.8	2.8	2.7	2.6
	23	-5.0	3.2	3.2	3.0	2.6
	32	0.0	3.6	3.6	3.0	2.6
	37	2.5	3.8	3.8	3.0	2.6
	43	6.0	4.1	4.0	3.0	2.6
	46	7.5	4.2	4.0	3.0	2.6
	50	10.0	4.4	4.0	3.0	2.6
	55	12.5	4.6	4.0	3.0	2.6
60	15.5	4.6	4.0	3.0	2.6	
40 (4.5)	-4	-20.0	2.6	2.5	2.5	2.4
	5	-15.0	3.0	3.0	3.0	2.9
	14	-10.0	3.5	3.5	3.4	3.2
	23	-5.0	4.0	4.0	3.8	3.2
	32	0.0	4.5	4.5	3.8	3.2
	37	2.5	4.8	4.7	3.8	3.2
	43	6.0	5.1	5.0	3.8	3.2
	46	7.5	5.3	5.0	3.8	3.2
	50	10.0	5.5	5.0	3.8	3.2
	55	12.5	5.8	5.0	3.8	3.2
60	15.5	5.8	5.0	3.8	3.2	
50 (5.6)	-4	-20.0	3.3	3.2	3.2	3.0
	5	-15.0	3.8	3.8	3.8	3.7
	14	-10.0	4.4	4.4	4.3	4.0
	23	-5.0	5.0	5.0	4.7	4.0
	32	0.0	5.7	5.7	4.7	4.0
	37	2.5	6.0	6.0	4.7	4.0
	43	6.0	6.5	6.3	4.7	4.0
	46	7.5	6.7	6.3	4.7	4.0
	50	10.0	7.0	6.3	4.7	4.0
	55	12.5	7.2	6.3	4.7	4.0
60	15.5	7.2	6.3	4.7	4.0	
63 (7.1)	-4	-20.0	4.2	4.0	4.0	3.8
	5	-15.0	4.8	4.8	4.8	4.6
	14	-10.0	5.6	5.6	5.5	5.1
	23	-5.0	6.4	6.4	6.0	5.1
	32	0.0	7.2	7.2	6.0	5.1
	37	2.5	7.6	7.6	6.0	5.1
	43	6.0	8.2	8.0	6.0	5.1
	46	7.5	8.5	8.0	6.0	5.1
	50	10.0	8.8	8.0	6.0	5.1
	55	12.5	9.2	8.0	6.0	5.1
60	15.5	9.2	8.0	6.0	5.1	
71 (8.0)	-4	-20.0	4.7	4.5	4.5	4.3
	5	-15.0	5.4	5.4	5.4	5.2
	14	-10.0	6.3	6.3	6.2	5.8
	23	-5.0	7.2	7.2	6.8	5.8
	32	0.0	8.1	8.1	6.8	5.8
	37	2.5	8.6	8.5	6.8	5.8
	43	6.0	9.2	9.0	6.8	5.8
	46	7.5	9.5	9.0	6.8	5.8
	50	10.0	9.9	9.0	6.8	5.8
	55	12.5	10.4	9.0	6.8	5.8
60	15.5	10.4	9.0	6.8	5.8	

Model size (Rated kW)	Outdoor air temp.		Indoor air temp.			
			59 °FDB	68 °FDB	77 °FDB	81 °FDB
			15.0°CDB	20.0°CDB	25.0°CDB	27.0°CDB
	°FWB	°CWB	SHC	SHC	SHC	SHC
80 (9.0)	-4	-20.0	5.2	5.0	5.0	4.8
	5	-15.0	6.0	6.0	6.0	5.8
	14	-10.0	7.0	7.0	6.9	6.4
	23	-5.0	8.0	8.0	7.5	6.4
	32	0.0	9.0	9.0	7.5	6.4
	37	2.5	9.6	9.5	7.5	6.4
	43	6.0	10.3	10.0	7.5	6.4
	46	7.5	10.6	10.0	7.5	6.4
	50	10.0	11.1	10.0	7.5	6.4
	55	12.5	11.5	10.0	7.5	6.4
60	15.5	11.5	10.0	7.5	6.4	
100 (11.2)	-4	-20.0	6.5	6.3	6.3	6.0
	5	-15.0	7.5	7.5	7.5	7.3
	14	-10.0	8.8	8.8	8.6	8.0
	23	-5.0	10.0	10.0	9.4	8.0
	32	0.0	11.3	11.3	9.4	8.0
	37	2.5	11.9	11.8	9.4	8.0
	43	6.0	12.8	12.5	9.4	8.0
	46	7.5	13.3	12.5	9.4	8.0
	50	10.0	13.8	12.5	9.4	8.0
	55	12.5	14.4	12.5	9.4	8.0
60	15.5	14.4	12.5	9.4	8.0	
125 (14.0)	-4	-20.0	8.3	8.0	8.0	7.7
	5	-15.0	9.6	9.6	9.6	9.3
	14	-10.0	11.2	11.2	11.0	10.2
	23	-5.0	12.8	12.8	12.0	10.2
	32	0.0	14.4	14.4	12.0	10.2
	37	2.5	15.3	15.1	12.0	10.2
	43	6.0	16.4	16.0	12.0	10.2
	46	7.5	17.0	16.0	12.0	10.2
	50	10.0	17.7	16.0	12.0	10.2
	55	12.5	18.4	16.0	12.0	10.2
60	15.5	18.4	16.0	12.0	10.2	
140 (16.0)	-4	-20.0	9.4	9.0	9.0	8.6
	5	-15.0	10.8	10.8	10.8	10.4
	14	-10.0	12.6	12.6	12.3	11.5
	23	-5.0	14.4	14.4	13.5	11.5
	32	0.0	16.2	16.2	13.5	11.5
	37	2.5	17.2	17.0	13.5	11.5
	43	6.0	18.5	18.0	13.5	11.5
	46	7.5	19.1	18.0	13.5	11.5
	50	10.0	19.9	18.0	13.5	11.5
	55	12.5	20.7	18.0	13.5	11.5
60	15.5	20.7	18.0	13.5	11.5	

kcal/h = kW x 860, Btu/h = kW x 3,412

2. CAPACITY TABLES

R410A Data G2

2-3a. Cooling capacity in combination with PUHY,PURY-P450,500,550,600,650YGM

PEFY-P-VMM-E

CA : Capacity(kW) SHC : Sensible Heat Capacity(kW)

Model size (Rated kW)	Outdoor air temp.		Indoor air temp.													
			71°FDB / 59°FWB		73°FDB / 61°FWB		77°FDB / 64°FWB		81°FDB / 66°FWB		82°FDB / 68°FWB		86°FDB / 72°FWB		90°FDB / 75°FWB	
			21.5°CDB / 15°CWB		23°CDB / 16°CWB		25°CDB / 18°CWB		27°CDB / 19°CWB		28°CDB / 20°CWB		30°CDB / 22°CWB		32°CDB / 24°CWB	
	°FDB	°CDB	CA	SHC	CA	SHC	CA	SHC	CA	SHC	CA	SHC	CA	SHC	CA	SHC
80 (9.0)	68	20.0	8.5	6.1	8.8	6.2	9.4	6.2	9.6	6.3	10.0	6.5	10.6	6.4	11.3	6.4
	73	22.5	8.5	6.1	8.7	6.2	9.3	6.2	9.5	6.2	9.9	6.5	10.6	6.4	11.2	6.3
	77	25.0	8.4	6.0	8.6	6.2	9.2	6.1	9.5	6.2	9.8	6.4	10.4	6.4	11.1	6.3
	82	27.5	8.3	6.0	8.5	6.1	9.1	6.1	9.4	6.1	9.7	6.4	10.4	6.3	10.8	6.2
	86	30.0	8.2	5.9	8.4	6.0	9.0	6.0	9.3	6.1	9.6	6.4	10.3	6.3	10.9	6.2
	91	32.5	8.1	5.9	8.3	6.0	8.8	6.0	9.1	6.0	9.5	6.3	10.2	6.3	10.8	6.2
	95	35.0	8.0	5.8	8.1	5.9	8.8	5.9	9.0	6.0	9.4	6.2	10.1	6.2	10.7	6.1
	100	37.5	7.9	5.8	8.1	5.9	8.6	5.9	8.9	5.9	9.3	6.2	9.9	6.2	10.6	6.1
	104	40.0	7.8	5.7	8.0	5.8	8.6	5.8	8.7	5.9	9.2	6.2	9.9	6.1	10.5	6.1
	110	43.0	7.7	5.7	7.9	5.8	8.5	5.8	8.6	5.8	9.1	6.1	9.7	6.1	10.4	6.0
100 (11.2)	68	20.0	10.6	8.3	10.9	8.5	11.6	8.5	12.0	8.6	12.5	9.0	13.2	8.9	14.1	8.8
	73	22.5	10.5	8.2	10.8	8.5	11.5	8.4	11.9	8.6	12.3	8.9	13.2	8.9	13.9	8.7
	77	25.0	10.4	8.2	10.7	8.4	11.4	8.4	11.8	8.5	12.2	8.9	13.0	8.8	13.8	8.7
	82	27.5	10.3	8.1	10.5	8.4	11.3	8.3	11.6	8.5	12.1	8.9	12.9	8.8	13.4	8.6
	86	30.0	10.2	8.1	10.4	8.3	11.2	8.3	11.5	8.4	12.0	8.8	12.8	8.7	13.6	8.6
	91	32.5	10.1	8.0	10.3	8.3	11.0	8.2	11.3	8.3	11.9	8.8	12.7	8.7	13.4	8.6
	95	35.0	10.0	8.0	10.1	8.2	10.9	8.2	11.2	8.3	11.6	8.7	12.5	8.6	13.3	8.5
	100	37.5	9.9	7.9	10.0	8.1	10.8	8.1	11.0	8.2	11.6	8.7	12.4	8.6	13.2	8.5
	104	40.0	9.7	7.8	9.9	8.1	10.7	8.1	10.9	8.2	11.4	8.6	12.3	8.6	13.1	8.4
	110	43.0	9.6	7.8	9.8	8.0	10.5	8.0	10.8	8.1	11.3	8.5	12.1	8.5	13.0	8.4
125 (14.0)	68	20.0	13.2	10.1	13.7	10.4	14.6	10.4	15.0	10.5	15.6	11.0	16.5	10.8	17.6	10.7
	73	22.5	13.2	10.1	13.5	10.4	14.4	10.3	14.8	10.5	15.4	10.9	16.5	10.8	17.4	10.7
	77	25.0	13.0	10.0	13.4	10.3	14.3	10.2	14.7	10.4	15.3	10.9	16.2	10.7	17.3	10.6
	82	27.5	12.9	10.0	13.2	10.2	14.1	10.2	14.6	10.4	15.1	10.8	16.1	10.7	16.8	10.4
	86	30.0	12.7	9.9	13.0	10.1	14.0	10.1	14.4	10.3	15.0	10.7	16.0	10.6	16.9	10.5
	91	32.5	12.6	9.8	12.9	10.1	13.7	10.0	14.1	10.2	14.8	10.7	15.8	10.6	16.8	10.4
	95	35.0	12.5	9.8	12.7	10.0	13.7	10.0	14.0	10.1	14.6	10.6	15.7	10.5	16.7	10.4
	100	37.5	12.3	9.7	12.6	9.9	13.4	9.9	13.8	10.0	14.5	10.5	15.5	10.4	16.5	10.3
	104	40.0	12.1	9.6	12.4	9.9	13.4	9.9	13.6	9.9	14.3	10.5	15.4	10.4	16.4	10.3
	110	43.0	12.0	9.6	12.3	9.8	13.2	9.8	13.4	9.9	14.1	10.4	15.1	10.3	16.2	10.2
140 (16.0)	68	20.0	15.1	11.2	15.6	11.6	16.6	11.5	17.1	11.6	17.8	12.2	18.9	12.0	20.2	11.9
	73	22.5	15.0	11.2	15.4	11.5	16.5	11.4	17.0	11.6	17.6	12.1	18.8	12.0	19.9	11.8
	77	25.0	14.9	11.1	15.3	11.4	16.3	11.3	16.8	11.5	17.4	12.0	18.6	11.9	19.8	11.7
	82	27.5	14.7	11.0	15.0	11.3	16.2	11.3	16.6	11.4	17.3	11.9	18.4	11.8	19.2	11.5
	86	30.0	14.6	11.0	14.9	11.2	16.0	11.2	16.5	11.4	17.1	11.9	18.2	11.7	19.4	11.6
	91	32.5	14.4	10.9	14.7	11.1	15.7	11.1	16.2	11.2	17.0	11.8	18.1	11.7	19.2	11.5
	95	35.0	14.2	10.8	14.5	11.0	15.6	11.0	16.0	11.2	16.6	11.7	17.9	11.6	19.0	11.4
	100	37.5	14.1	10.7	14.4	11.0	15.4	10.9	15.8	11.1	16.6	11.6	17.7	11.5	18.9	11.4
	104	40.0	13.8	10.6	14.2	10.9	15.3	10.9	15.5	11.0	16.3	11.5	17.6	11.5	18.7	11.3
	110	43.0	13.8	10.6	14.0	10.8	15.0	10.8	15.4	10.9	16.2	11.5	17.3	11.4	18.6	11.3

kcal/h = kW x 860, Btu/h = kW x 3,412

2. CAPACITY TABLES

R410A Data G2

2-3b. Heating capacity in combination with PUHY,PURY-P450,500,550,600,650YGM

PEFY-P-VMM-E

SHC : Sensible Heat Capacity(kW)

Model size (Rated kW)	Outdoor air temp.		Indoor air temp.			
			59 °FDB	68 °FDB	77 °FDB	81 °FDB
			15.0°CDB	20.0°CDB	25.0°CDB	27.0°CDB
	°FWB	°CWB	SHC	SHC	SHC	SHC
20 (2.2)	-4	-20.0	1.3	1.3	1.3	1.3
	5	-15.0	1.6	1.5	1.5	1.5
	14	-10.0	1.8	1.8	1.7	1.7
	23	-5.0	2.1	2.0	1.9	1.8
	32	0.0	2.3	2.3	2.0	1.8
	37	2.5	2.4	2.4	2.0	1.8
	43	6.0	2.6	2.5	2.0	1.8
	46	7.5	2.7	2.5	2.0	1.8
	50	10.0	2.8	2.5	2.0	1.8
	55	12.5	2.9	2.5	2.0	1.8
60	15.5	2.9	2.5	2.0	1.8	
25 (2.8)	-4	-20.0	1.7	1.6	1.6	1.6
	5	-15.0	2.0	1.9	1.9	1.9
	14	-10.0	2.3	2.2	2.2	2.1
	23	-5.0	2.6	2.6	2.5	2.3
	32	0.0	2.9	2.9	2.5	2.3
	37	2.5	3.1	3.0	2.5	2.3
	43	6.0	3.3	3.2	2.5	2.3
	46	7.5	3.4	3.2	2.5	2.3
	50	10.0	3.6	3.2	2.5	2.3
	55	12.5	3.7	3.2	2.5	2.3
60	15.5	3.7	3.2	2.5	2.3	
32 (3.6)	-4	-20.0	2.1	2.0	2.0	2.0
	5	-15.0	2.5	2.4	2.4	2.3
	14	-10.0	2.9	2.8	2.7	2.6
	23	-5.0	3.3	3.2	3.1	2.8
	32	0.0	3.7	3.6	3.2	2.8
	37	2.5	3.8	3.8	3.2	2.8
	43	6.0	4.1	4.0	3.2	2.8
	46	7.5	4.2	4.0	3.2	2.8
	50	10.0	4.4	4.0	3.2	2.8
	55	12.5	4.6	4.0	3.2	2.8
60	15.5	4.6	4.0	3.2	2.8	
40 (4.5)	-4	-20.0	2.7	2.6	2.6	2.5
	5	-15.0	3.1	3.0	3.0	2.9
	14	-10.0	3.6	3.5	3.4	3.3
	23	-5.0	4.1	4.0	3.9	3.5
	32	0.0	4.6	4.5	4.0	3.5
	37	2.5	4.8	4.8	4.0	3.5
	43	6.0	5.2	5.0	4.0	3.5
	46	7.5	5.3	5.0	4.0	3.5
	50	10.0	5.6	5.0	4.0	3.5
	55	12.5	5.8	5.0	4.0	3.5
60	15.5	5.8	5.0	4.0	3.5	
50 (5.6)	-4	-20.0	3.3	3.2	3.2	3.2
	5	-15.0	3.9	3.8	3.8	3.7
	14	-10.0	4.5	4.4	4.3	4.2
	23	-5.0	5.2	5.0	4.9	4.4
	32	0.0	5.8	5.7	5.0	4.4
	37	2.5	6.0	6.0	5.0	4.4
	43	6.0	6.5	6.3	5.0	4.4
	46	7.5	6.7	6.3	5.0	4.4
	50	10.0	7.0	6.3	5.0	4.4
	55	12.5	7.3	6.3	5.0	4.4
60	15.5	7.3	6.3	5.0	4.4	
63 (7.1)	-4	-20.0	4.2	4.1	4.1	4.0
	5	-15.0	5.0	4.8	4.8	4.6
	14	-10.0	5.8	5.6	5.4	5.3
	23	-5.0	6.6	6.4	6.2	5.6
	32	0.0	7.4	7.2	6.4	5.6
	37	2.5	7.7	7.6	6.4	5.6
	43	6.0	8.2	8.0	6.4	5.6
	46	7.5	8.5	8.0	6.4	5.6
	50	10.0	8.9	8.0	6.4	5.6
	55	12.5	9.3	8.0	6.4	5.6
60	15.5	9.3	8.0	6.4	5.6	
71 (8.0)	-4	-20.0	4.8	4.6	4.6	4.5
	5	-15.0	5.6	5.4	5.4	5.2
	14	-10.0	6.5	6.3	6.1	5.9
	23	-5.0	7.4	7.2	6.9	6.3
	32	0.0	8.3	8.1	7.2	6.3
	37	2.5	8.6	8.6	7.2	6.3
	43	6.0	9.3	9.0	7.2	6.3
	46	7.5	9.5	9.0	7.2	6.3
	50	10.0	10.0	9.0	7.2	6.3
	55	12.5	10.4	9.0	7.2	6.3
60	15.5	10.4	9.0	7.2	6.3	

Model size (Rated kW)	Outdoor air temp.		Indoor air temp.			
			59 °FDB	68 °FDB	77 °FDB	81 °FDB
			15.0°CDB	20.0°CDB	25.0°CDB	27.0°CDB
	°FWB	°CWB	SHC	SHC	SHC	SHC
80 (9.0)	-4	-20.0	5.3	5.1	5.1	5.0
	5	-15.0	6.3	6.1	6.0	5.8
	14	-10.0	7.2	7.0	6.8	6.6
	23	-5.0	8.2	8.0	7.7	7.1
	32	0.0	9.2	9.0	8.0	7.1
	37	2.5	9.6	9.5	8.0	7.1
	43	6.0	10.3	10.0	8.0	7.1
	46	7.5	10.6	10.0	8.0	7.1
	50	10.0	11.1	10.0	8.0	7.1
	55	12.5	11.6	10.0	8.0	7.1
60	15.5	11.6	10.0	8.0	7.1	
100 (11.2)	-4	-20.0	6.6	6.4	6.4	6.3
	5	-15.0	7.8	7.6	7.5	7.3
	14	-10.0	9.0	8.8	8.5	8.3
	23	-5.0	10.3	10.0	9.6	8.8
	32	0.0	11.5	11.3	9.9	8.8
	37	2.5	12.0	11.9	9.9	8.8
	43	6.0	12.9	12.5	9.9	8.8
	46	7.5	13.3	12.5	9.9	8.8
	50	10.0	13.9	12.5	9.9	8.8
	55	12.5	14.5	12.5	9.9	8.8
60	15.5	14.5	12.5	9.9	8.8	
125 (14.0)	-4	-20.0	8.5	8.2	8.2	8.0
	5	-15.0	10.0	9.7	9.6	9.3
	14	-10.0	11.5	11.2	10.9	10.6
	23	-5.0	13.1	12.8	12.3	11.3
	32	0.0	14.7	14.4	12.7	11.3
	37	2.5	15.4	15.2	12.7	11.3
	43	6.0	16.5	16.0	12.7	11.3
	46	7.5	17.0	16.0	12.7	11.3
	50	10.0	17.8	16.0	12.7	11.3
	55	12.5	18.6	16.0	12.7	11.3
60	15.5	18.6	16.0	12.7	11.3	
140 (16.0)	-4	-20.0	9.5	9.2	9.2	9.0
	5	-15.0	11.3	10.9	10.8	10.4
	14	-10.0	13.0	12.6	12.2	11.9
	23	-5.0	14.8	14.4	13.9	12.7
	32	0.0	16.6	16.2	14.3	12.7
	37	2.5	17.3	17.1	14.3	12.7
	43	6.0	18.5	18.0	14.3	12.7
	46	7.5	19.1	18.0	14.3	12.7
	50	10.0	20.0	18.0	14.3	12.7
	55	12.5	20.9	18.0	14.3	12.7
60	15.5	20.9	18.0	14.3	12.7	

kcal/h = kW x 860, Btu/h = kW x 3,412

2. CAPACITY TABLES

R410A Data G2

2-4b. Heating capacity in combination with PQHY,PQRY-P200,250YGM, PQHY,PQRY-P400,500YSGM

PEFY-P-VMM-E

SHC : Sensible Heat Capacity(kW)

Model size (Rated kW)	Water temp.		Indoor air temp. : °CDB				
			59 °FDB	66 °FDB	68 °FDB	77 °FDB	81 °FDB
			15.0°CDB	19.0°CDB	20.0°CDB	25.0°CDB	27.0°CDB
°F	°C	SHC	SHC	SHC	SHC	SHC	
20 (2.2)	50	10	2.0	2.0	2.0	1.7	1.5
	68	20	2.5	2.5	2.5	2.1	1.9
	86	30	2.5	2.5	2.5	2.1	1.9
	104	40	2.5	2.5	2.5	2.1	1.9
	113	45	2.5	2.5	2.5	2.1	1.9
25 (2.8)	50	10	2.5	2.5	2.5	2.1	2.0
	68	20	3.2	3.2	3.2	2.7	2.5
	86	30	3.2	3.2	3.2	2.7	2.5
	104	40	3.2	3.2	3.2	2.7	2.5
	113	45	3.2	3.2	3.2	2.7	2.5
32 (3.6)	50	10	3.2	3.2	3.2	2.7	2.4
	68	20	4.0	4.0	4.0	3.4	3.1
	86	30	4.0	4.0	4.0	3.4	3.1
	104	40	4.0	4.0	4.0	3.4	3.1
	113	45	4.0	4.0	4.0	3.4	3.1
40 (4.5)	50	10	4.0	4.0	4.0	3.4	3.1
	68	20	5.0	5.0	5.0	4.2	3.9
	86	30	5.0	5.0	5.0	4.2	3.9
	104	40	5.0	5.0	5.0	4.2	3.9
	113	45	5.0	5.0	5.0	4.2	3.9
50 (5.6)	50	10	5.0	5.0	5.0	4.2	3.9
	68	20	6.3	6.3	6.3	5.3	4.9
	86	30	6.3	6.3	6.3	5.3	4.9
	104	40	6.3	6.3	6.3	5.3	4.9
	113	45	6.3	6.3	6.3	5.3	4.9
63 (7.1)	50	10	6.3	6.3	6.3	5.4	4.9
	68	20	8.0	8.0	8.0	6.8	6.2
	86	30	8.0	8.0	8.0	6.8	6.2
	104	40	8.0	8.0	8.0	6.8	6.2
	113	45	8.0	8.0	8.0	6.8	6.2
71 (8.0)	50	10	7.1	7.1	7.1	6.0	5.5
	68	20	9.0	9.0	9.0	7.6	7.0
	86	30	9.0	9.0	9.0	7.6	7.0
	104	40	9.0	9.0	9.0	7.6	7.0
	113	45	9.0	9.0	9.0	7.6	7.0
80 (9.0)	50	10	7.9	7.9	7.9	6.7	6.1
	68	20	10.0	10.0	10.0	8.5	7.7
	86	30	10.0	10.0	10.0	8.5	7.7
	104	40	10.0	10.0	10.0	8.5	7.7
	113	45	10.0	10.0	10.0	8.5	7.7
100 (11.2)	50	10	9.9	9.9	9.9	8.4	7.7
	68	20	12.5	12.5	12.5	10.6	9.7
	86	30	12.5	12.5	12.5	10.6	9.7
	104	40	12.5	12.5	12.5	10.6	9.7
	113	45	12.5	12.5	12.5	10.6	9.7
125 (14.0)	50	10	12.7	12.7	12.7	10.7	9.8
	68	20	16.0	16.0	16.0	13.6	12.4
	86	30	16.0	16.0	16.0	13.6	12.4
	104	40	16.0	16.0	16.0	13.6	12.4
	113	45	16.0	16.0	16.0	13.6	12.4
140 (16.0)	50	10	14.2	14.2	14.2	12.1	11.0
	68	20	18.0	18.0	18.0	15.3	13.9
	86	30	18.0	18.0	18.0	15.3	13.9
	104	40	18.0	18.0	18.0	15.3	13.9
	113	45	18.0	18.0	18.0	15.3	13.9

kcal/h = kW x 860, Btu/h = kW x 3,412

2. CAPACITY TABLES

R410A Data G2

2-5a. Cooling capacity in combination with PUMY-P100,125,140YHM

PEFY-P-VMM-E

CA : Capacity(kW) SHC : Sensible Heat Capacity(kW)

Model size (Rated kW)	Outdoor air temp.		Indoor air temp.													
			71°FDB / 59°F WB		73°FDB / 61°F WB		77°FDB / 64°F WB		81°FDB / 66°F WB		82°FDB / 68°F WB		86°FDB / 72°F WB		90°FDB / 75°F WB	
	°FDB	°CDB	21.5°CDB / 15°CWB		23°CDB / 16°CWB		25°CDB / 18°CWB		27°CDB / 19°CWB		28°CDB / 20°CWB		30°CDB / 22°CWB		32°CDB / 24°CWB	
		CA	SHC	CA	SHC	CA	SHC	CA	SHC	CA	SHC	CA	SHC	CA	SHC	
80 (9.0)	68	20.0	8.6	5.9	8.8	6.0	9.4	6.0	9.6	6.4	9.9	6.4	10.4	6.3	11.0	6.2
	73	22.5	8.4	5.8	8.7	6.0	9.2	6.0	9.5	6.3	9.8	6.3	10.3	6.2	10.9	6.1
	77	25.0	8.3	5.7	8.6	5.9	9.1	5.9	9.4	6.3	9.7	6.2	10.2	6.2	10.8	6.1
	82	27.5	8.2	5.6	8.5	5.8	9.0	5.8	9.3	6.2	9.6	6.2	10.1	6.1	10.6	6.0
	86	30.0	8.1	5.5	8.4	5.7	8.9	5.7	9.2	6.1	9.5	6.1	10.0	6.0	10.5	5.9
	91	32.5	7.9	5.4	8.2	5.6	8.8	5.7	9.0	6.0	9.3	6.0	9.9	6.0	10.4	5.9
	95	35.0	7.8	5.3	8.1	5.5	8.6	5.6	8.9	5.9	9.2	5.9	9.8	5.9	10.3	5.8
	100	37.5	7.6	5.2	7.9	5.4	8.5	5.5	8.8	5.8	9.1	5.8	9.7	5.8	10.2	5.8
	104	40.0	7.4	5.1	7.7	5.3	8.3	5.4	8.6	5.7	8.9	5.8	9.5	5.8	10.1	5.7
	110	43.0	7.3	5.0	7.6	5.2	8.2	5.3	8.5	5.6	8.8	5.7	9.4	5.7	10.0	5.6
100 (11.2)	68	20.0	10.6	8.1	11.0	8.4	11.6	8.4	12.0	8.9	12.3	8.9	13.0	8.8	13.7	8.8
	73	22.5	10.5	8.0	10.8	8.2	11.5	8.3	11.8	8.8	12.2	8.8	12.9	8.8	13.5	8.7
	77	25.0	10.4	7.9	10.7	8.1	11.4	8.2	11.7	8.7	12.0	8.7	12.7	8.7	13.4	8.6
	82	27.5	10.2	7.8	10.6	8.0	11.2	8.1	11.6	8.6	11.9	8.6	12.6	8.6	13.2	8.5
	86	30.0	10.1	7.7	10.4	7.9	11.1	8.0	11.4	8.5	11.8	8.5	12.4	8.5	13.1	8.4
	91	32.5	9.9	7.5	10.2	7.8	10.9	7.9	11.3	8.3	11.6	8.4	12.3	8.4	13.0	8.3
	95	35.0	9.7	7.4	10.0	7.6	10.7	7.7	11.1	8.2	11.4	8.3	12.2	8.3	12.9	8.2
	100	37.5	9.5	7.2	9.8	7.5	10.6	7.6	10.9	8.1	11.3	8.1	12.0	8.2	12.7	8.2
	104	40.0	9.3	7.0	9.6	7.3	10.4	7.5	10.8	8.0	11.1	8.0	11.9	8.1	12.6	8.1
	110	43.0	9.0	6.9	9.4	7.2	10.2	7.3	10.5	7.8	10.9	7.9	11.6	7.9	12.4	7.9
125 (14.0)	68	20.0	13.3	9.9	13.7	10.2	14.6	10.2	15.0	10.8	15.4	10.8	16.2	10.8	17.1	10.6
	73	22.5	13.1	9.8	13.5	10.1	14.4	10.1	14.8	10.7	15.2	10.7	16.1	10.7	16.9	10.5
	77	25.0	13.0	9.6	13.4	9.9	14.2	10.0	14.6	10.6	15.1	10.6	15.9	10.5	16.7	10.4
	82	27.5	12.8	9.5	13.2	9.8	14.0	9.9	14.5	10.5	14.9	10.5	15.7	10.4	16.6	10.3
	86	30.0	12.6	9.4	13.0	9.7	13.9	9.7	14.3	10.3	14.7	10.3	15.5	10.3	16.4	10.2
	91	32.5	12.3	9.2	12.8	9.5	13.6	9.6	14.1	10.2	14.5	10.2	15.4	10.2	16.2	10.1
	95	35.0	12.1	9.0	12.5	9.3	13.4	9.4	13.9	10.0	14.3	10.1	15.2	10.1	16.1	10.0
	100	37.5	11.8	8.8	12.3	9.1	13.2	9.3	13.7	9.9	14.1	9.9	15.0	10.0	15.9	9.9
	104	40.0	11.6	8.6	12.0	8.9	13.0	9.1	13.4	9.7	13.9	9.8	14.8	9.8	15.8	9.8
	110	43.0	11.3	8.4	11.8	8.7	12.7	8.9	13.2	9.5	13.6	9.6	14.6	9.7	15.5	9.7
140 (16.0)	68	20.0	14.7	10.6	15.2	10.9	16.1	10.9	16.6	11.6	17.1	11.6	18.0	11.5	18.9	11.3
	73	22.5	14.5	10.4	15.0	10.8	15.9	10.8	16.4	11.4	16.9	11.4	17.8	11.3	18.7	11.2
	77	25.0	14.3	10.3	14.8	10.6	15.7	10.7	16.2	11.3	16.7	11.3	17.6	11.2	18.5	11.1
	82	27.5	14.1	10.2	14.6	10.5	15.5	10.5	16.0	11.2	16.5	11.2	17.4	11.1	18.3	11.0
	86	30.0	14.0	10.0	14.4	10.3	15.3	10.4	15.8	11.0	16.3	11.0	17.2	11.0	18.1	10.8
	91	32.5	13.7	9.8	14.1	10.2	15.1	10.2	15.6	10.9	16.1	10.9	17.0	10.9	18.0	10.7
	95	35.0	13.4	9.6	13.9	10.0	14.9	10.1	15.3	10.7	15.8	10.7	16.8	10.7	17.8	10.6
	100	37.5	13.1	9.4	13.6	9.8	14.6	9.9	15.1	10.5	15.6	10.6	16.6	10.6	17.6	10.5
	104	40.0	12.8	9.2	13.3	9.6	14.4	9.7	14.9	10.4	15.4	10.4	16.4	10.5	17.5	10.4
	110	43.0	12.5	9.0	13.0	9.3	14.1	9.5	14.6	10.2	15.1	10.2	16.1	10.3	17.2	10.3

kcal/h = kW x 860, Btu/h = kW x 3,412

2. CAPACITY TABLES

R410A Data G2

2-5b. Heating capacity in combination with PUMY-P100,125,140YHM

PEFY-P-VMM-E

SHC : Sensible Heat Capacity(kW)

Model size (Rated kW)	Outdoor air temp.		Indoor air temp.			
			59 °FDB	68 °FDB	77 °FDB	81 °FDB
			15.0°CDB	20.0°CDB	25.0°CDB	27.0°CDB
	°FWB	°CWB	SHC	SHC	SHC	SHC
20 (2.2)	-4	-20.0	1.6	1.6	1.5	1.5
	5	-15.0	1.8	1.7	1.6	1.6
	14	-10.0	1.9	1.8	1.8	1.8
	23	-5.0	2.1	2.1	2.0	2.0
	32	0.0	2.4	2.3	2.2	2.2
	37	2.5	2.5	2.4	2.3	2.3
	43	6.0	2.6	2.5	2.5	2.4
	46	7.5	2.7	2.7	2.5	2.4
	50	10.0	2.8	2.8	2.5	2.4
	55	12.5	3.0	2.9	2.5	2.4
60	15.5	3.0	2.9	2.5	2.4	
25 (2.8)	-4	-20.0	2.1	2.0	1.9	1.9
	5	-15.0	2.2	2.1	2.1	2.0
	14	-10.0	2.4	2.3	2.3	2.2
	23	-5.0	2.7	2.7	2.5	2.5
	32	0.0	3.0	2.9	2.8	2.8
	37	2.5	3.2	3.1	3.0	2.9
	43	6.0	3.3	3.2	3.2	3.1
	46	7.5	3.5	3.4	3.2	3.1
	50	10.0	3.6	3.5	3.2	3.1
	55	12.5	3.8	3.7	3.2	3.1
60	15.5	3.9	3.7	3.2	3.1	
32 (3.6)	-4	-20.0	2.6	2.5	2.4	2.4
	5	-15.0	2.8	2.7	2.6	2.6
	14	-10.0	3.0	2.9	2.8	2.8
	23	-5.0	3.4	3.3	3.2	3.1
	32	0.0	3.8	3.7	3.5	3.5
	37	2.5	4.0	3.8	3.7	3.7
	43	6.0	4.1	4.0	4.0	3.9
	46	7.5	4.3	4.2	4.0	3.9
	50	10.0	4.5	4.4	4.0	3.9
	55	12.5	4.7	4.6	4.0	3.9
60	15.5	4.8	4.6	4.0	3.9	
40 (4.5)	-4	-20.0	3.3	3.2	3.0	3.0
	5	-15.0	3.5	3.4	3.3	3.2
	14	-10.0	3.8	3.7	3.6	3.5
	23	-5.0	4.3	4.2	4.0	3.9
	32	0.0	4.7	4.6	4.4	4.4
	37	2.5	5.0	4.8	4.7	4.6
	43	6.0	5.1	5.0	5.0	4.9
	46	7.5	5.4	5.3	5.0	4.9
	50	10.0	5.7	5.5	5.0	4.9
	55	12.5	5.9	5.8	5.0	4.9
60	15.5	6.1	5.8	5.0	4.9	
50 (5.6)	-4	-20.0	4.1	4.0	3.8	3.7
	5	-15.0	4.4	4.2	4.1	4.0
	14	-10.0	4.7	4.6	4.5	4.4
	23	-5.0	5.4	5.2	5.0	4.9
	32	0.0	5.9	5.8	5.5	5.5
	37	2.5	6.2	6.0	5.9	5.8
	43	6.0	6.4	6.3	6.2	6.1
	46	7.5	6.8	6.7	6.2	6.1
	50	10.0	7.1	6.9	6.2	6.1
	55	12.5	7.4	7.2	6.2	6.1
60	15.5	7.6	7.2	6.2	6.1	
63 (7.1)	-4	-20.0	5.2	5.0	4.8	4.7
	5	-15.0	5.6	5.4	5.2	5.1
	14	-10.0	6.0	5.8	5.7	5.6
	23	-5.0	6.8	6.6	6.3	6.2
	32	0.0	7.5	7.4	7.0	7.0
	37	2.5	7.9	7.7	7.4	7.4
	43	6.0	8.2	8.0	7.9	7.8
	46	7.5	8.6	8.5	7.9	7.8
	50	10.0	9.0	8.8	7.9	7.8
	55	12.5	9.4	9.2	7.9	7.8
60	15.5	9.7	9.2	7.9	7.8	
71 (8.0)	-4	-20.0	5.9	5.7	5.4	5.3
	5	-15.0	6.3	6.0	5.9	5.8
	14	-10.0	6.8	6.6	6.4	6.3
	23	-5.0	7.7	7.5	7.1	7.0
	32	0.0	8.5	8.3	7.9	7.8
	37	2.5	8.9	8.6	8.4	8.3
	43	6.0	9.2	9.0	8.9	8.7
	46	7.5	9.7	9.5	8.9	8.7
	50	10.0	10.2	9.9	8.9	8.7
	55	12.5	10.6	10.4	8.9	8.7
60	15.5	10.9	10.4	8.9	8.7	

Model size (Rated kW)	Outdoor air temp.		Indoor air temp.			
			59 °FDB	68 °FDB	77 °FDB	81 °FDB
			15.0°CDB	20.0°CDB	25.0°CDB	27.0°CDB
	°FWB	°CWB	SHC	SHC	SHC	SHC
80 (9.0)	-4	-20.0	6.5	6.3	6.0	5.9
	5	-15.0	7.0	6.7	6.5	6.4
	14	-10.0	7.5	7.3	7.1	7.0
	23	-5.0	8.5	8.3	7.9	7.8
	32	0.0	9.4	9.2	8.8	8.7
	37	2.5	9.9	9.6	9.3	9.2
	43	6.0	10.2	10.0	9.9	9.7
	46	7.5	10.8	10.6	9.9	9.7
	50	10.0	11.3	11.0	9.9	9.7
	55	12.5	11.8	11.5	9.9	9.7
60	15.5	12.1	11.5	9.9	9.7	
100 (11.2)	-4	-20.0	8.1	7.9	7.5	7.4
	5	-15.0	8.8	8.4	8.1	8.0
	14	-10.0	9.4	9.1	8.9	8.8
	23	-5.0	10.6	10.4	9.9	9.8
	32	0.0	11.8	11.5	11.0	10.9
	37	2.5	12.4	12.0	11.6	11.5
	43	6.0	12.8	12.5	12.4	12.1
	46	7.5	13.5	13.3	12.4	12.1
	50	10.0	14.1	13.8	12.4	12.1
	55	12.5	14.8	14.4	12.4	12.1
60	15.5	15.1	14.4	12.4	12.1	
125 (14.0)	-4	-20.0	10.4	10.1	9.6	9.4
	5	-15.0	11.2	10.7	10.4	10.2
	14	-10.0	12.0	11.7	11.4	11.2
	23	-5.0	13.6	13.3	12.6	12.5
	32	0.0	15.0	14.7	14.1	13.9
	37	2.5	15.8	15.4	14.9	14.7
	43	6.0	16.3	16.0	15.8	15.5
	46	7.5	17.3	17.0	15.8	15.5
	50	10.0	18.1	17.6	15.8	15.5
	55	12.5	18.9	18.4	15.8	15.5
60	15.5	19.4	18.4	15.8	15.5	
140 (16.0)	-4	-20.0	11.7	11.3	10.8	10.6
	5	-15.0	12.6	12.1	11.7	11.5
	14	-10.0	13.5	13.1	12.8	12.6
	23	-5.0	15.3	14.9	14.2	14.0
	32	0.0	16.9	16.6	15.8	15.7
	37	2.5	17.8	17.3	16.7	16.6
	43	6.0	18.4	18.0	17.8	17.5
	46	7.5	19.4	19.1	17.8	17.5
	50	10.0	20.3	19.8	17.8	17.5
	55	12.5	21.2	20.7	17.8	17.5
60	15.5	21.8	20.7	17.8	17.5	

kcal/h = kW x 860, Btu/h = kW x 3,412

3-1. Sound levels

PEFY-P-VMM-E

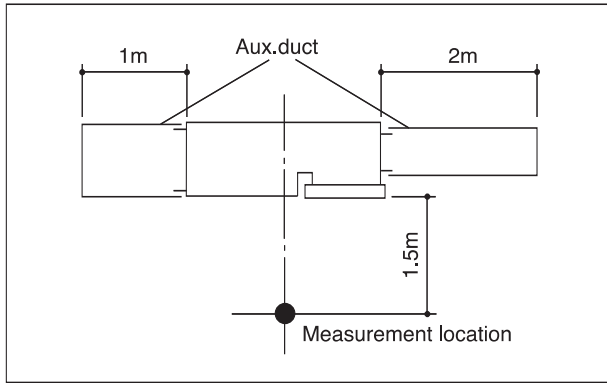

* Measured in anechoic room.

Sound level at anechoic room : Low-Mid-High

	Sound level dB (A)		
	Low	Mid	High
PEFY-P20VMM-E	23-28-31	27-30-32	29-34-39
PEFY-P25VMM-E			
PEFY-P32VMM-E	26-30-33	28-32-35	32-36-39
PEFY-P40VMM-E	29-32-35	31-34-37	33-37-41
PEFY-P50VMM-E	29-34-37	31-35-38	34-38-41
PEFY-P63VMM-E	30-34-37	31-35-38	34-38-41
PEFY-P71VMM-E			
PEFY-P80VMM-E			
PEFY-P100VMM-E	40-44	-	43-47
PEFY-P125VMM-E	42-45	-	44-47
PEFY-P140VMM-E	42-45	-	44-47

* External static pressure of PEFY-P20~80VMM-E

Low : 30Pa at 220,230,240V, 50Hz
 Mid : 50Pa at 220,230,240V, 50Hz
 High : 100Pa at 220,230,240V, 50Hz

* External static pressure of PEFY-P100~140VMM-E

Low : 50Pa at 220,230,240V, 50Hz
 High : 130Pa at 220,230,240V, 50Hz

3-2. NC curves

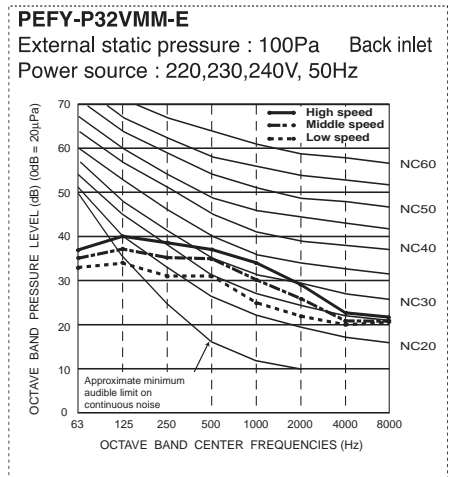
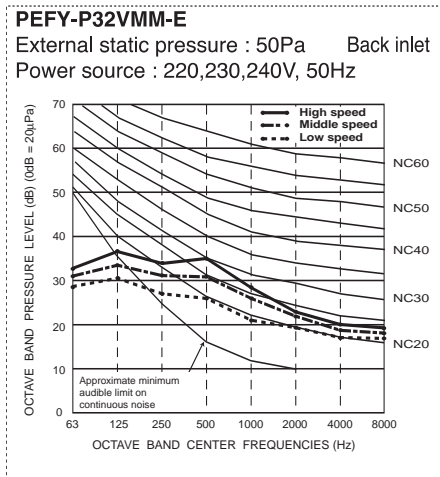
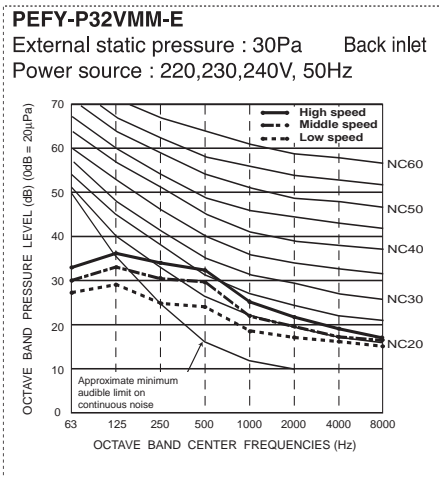
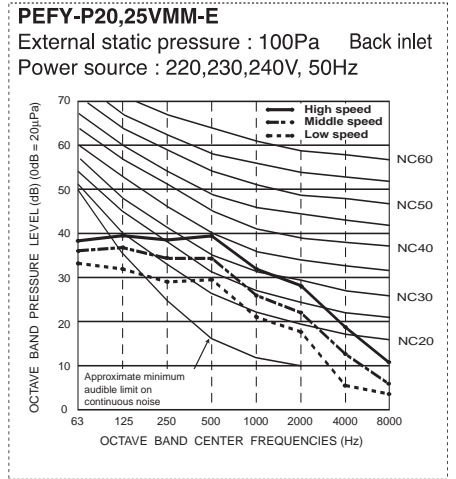
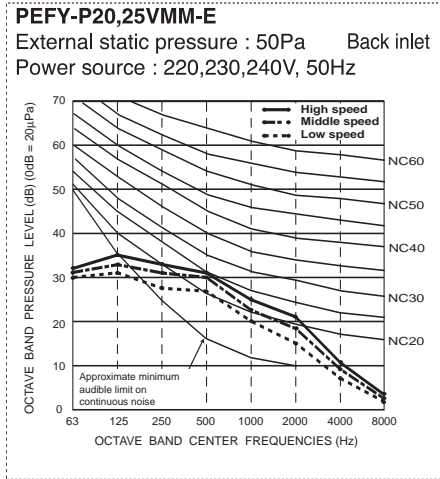
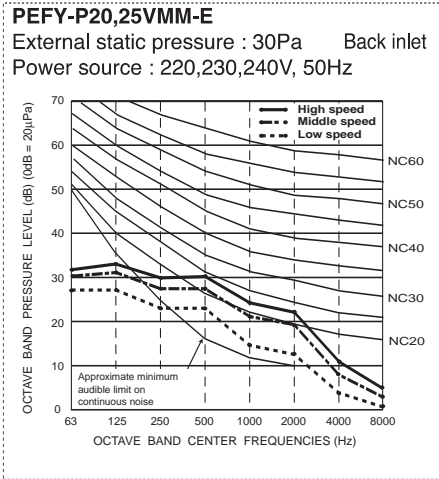

3-2. NC curves

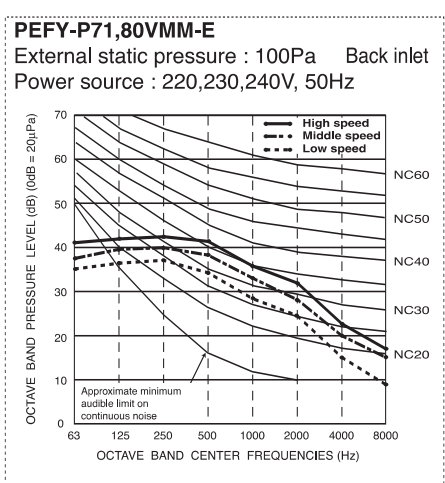
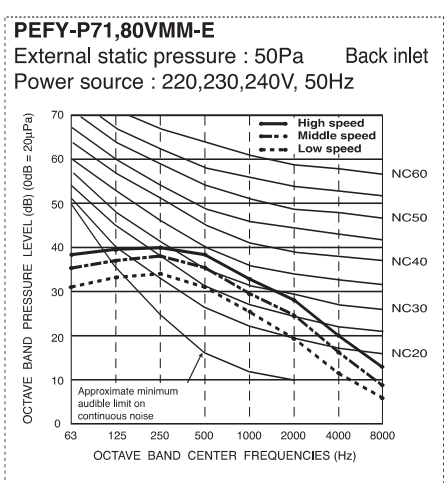
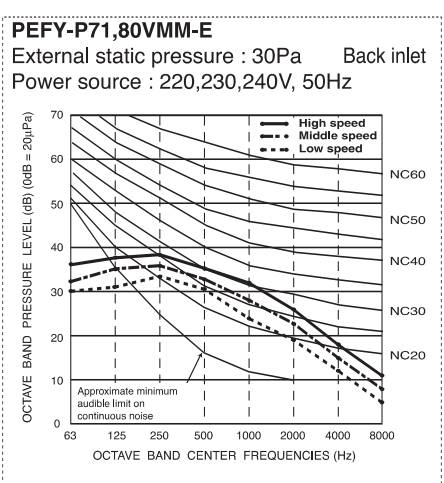
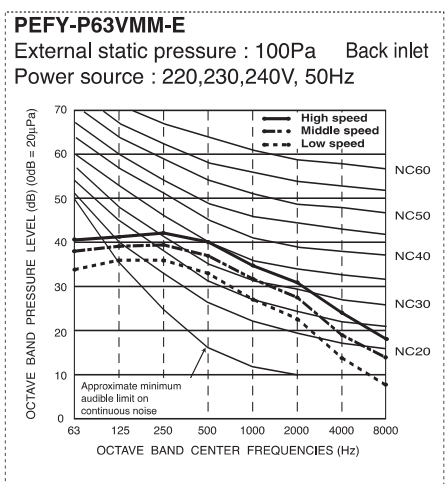
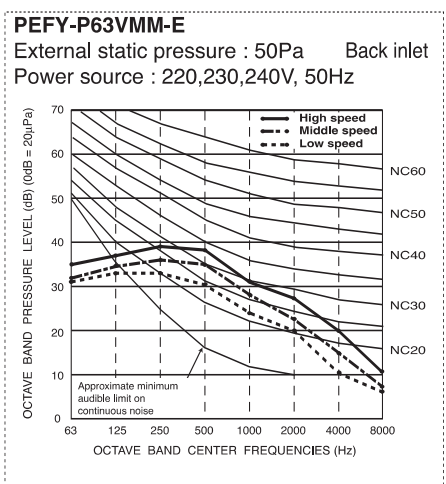
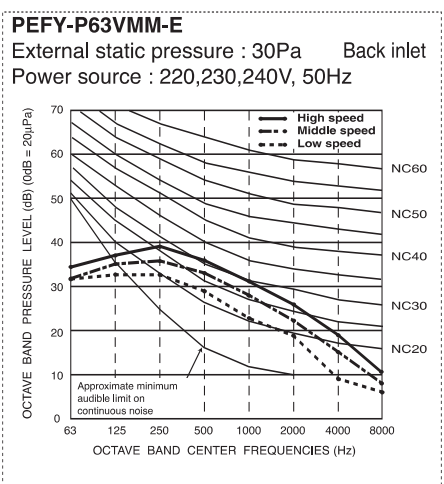
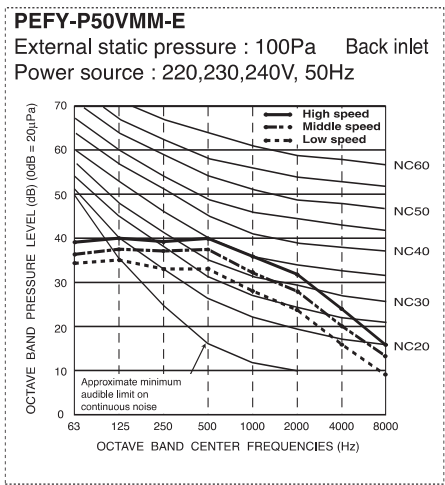
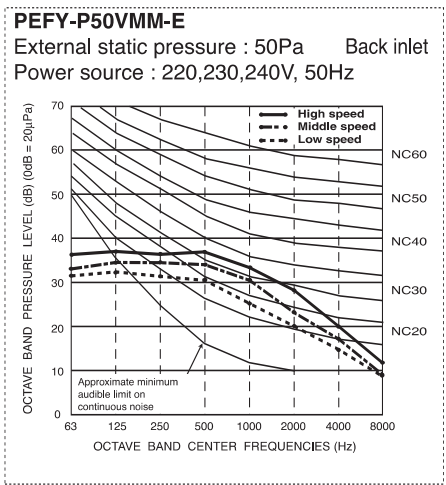
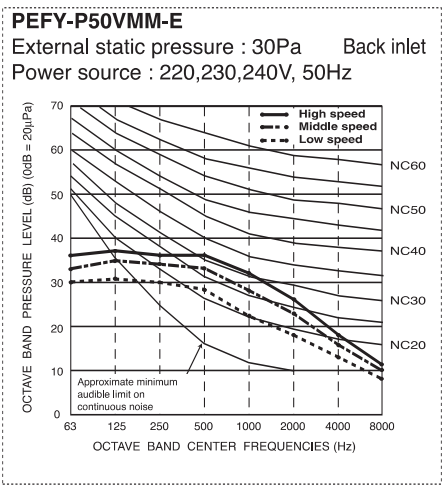
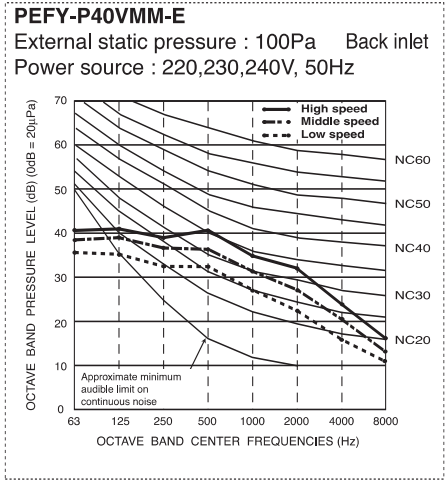
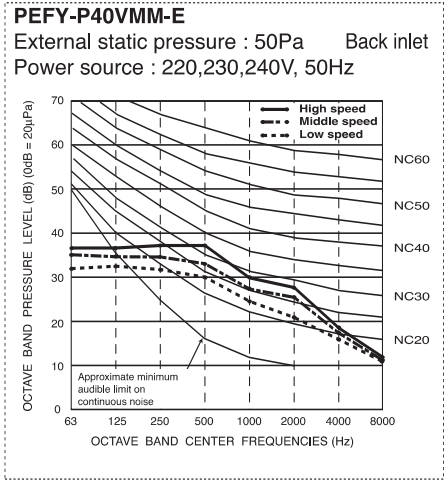
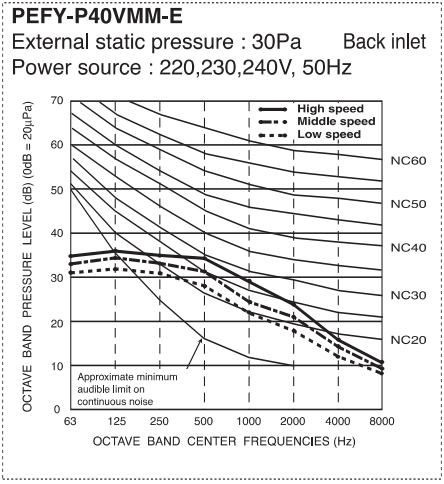

3-2. NC curves

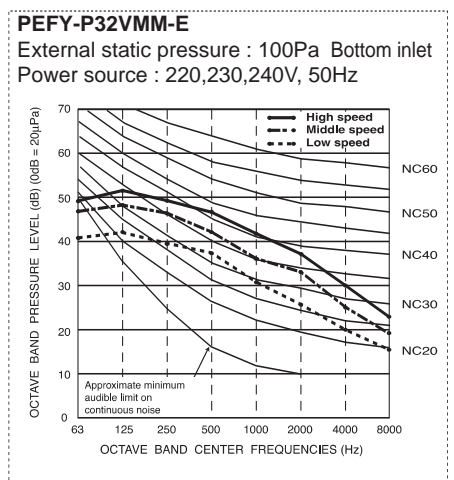
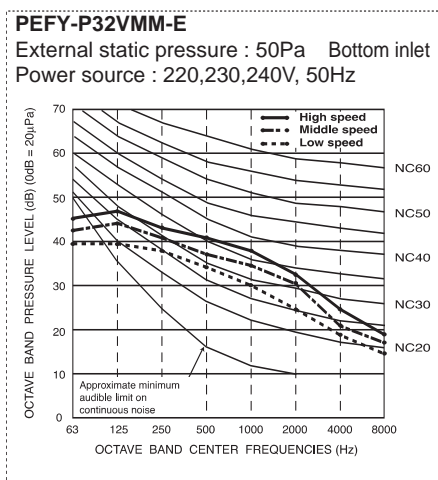
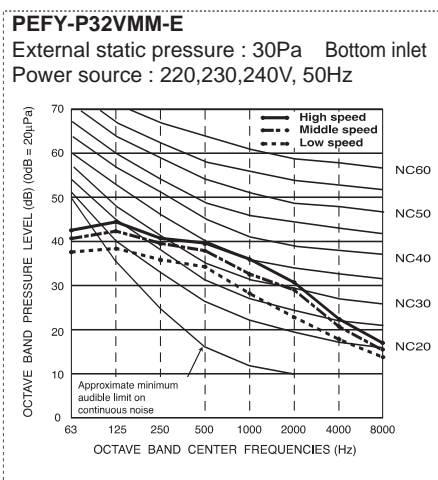
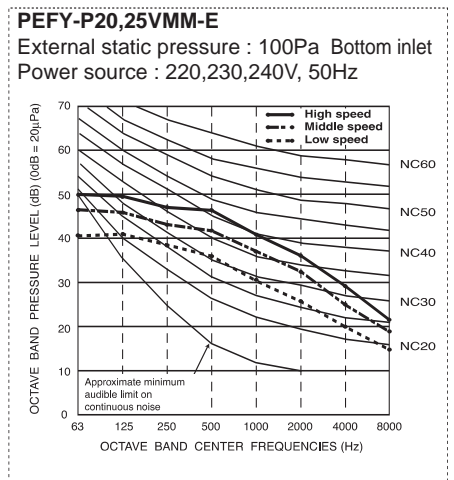
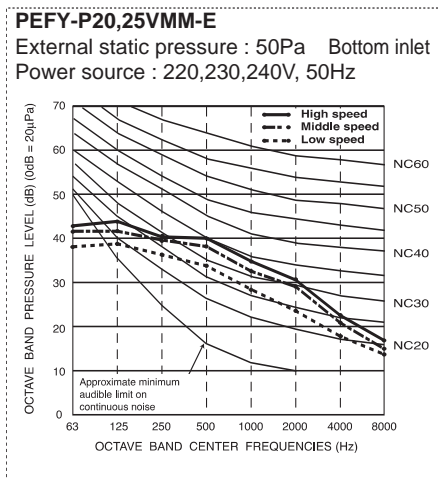
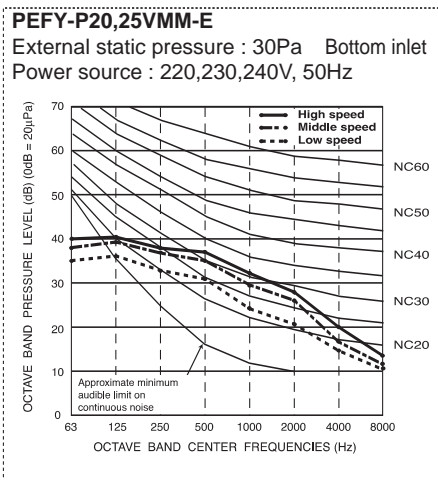
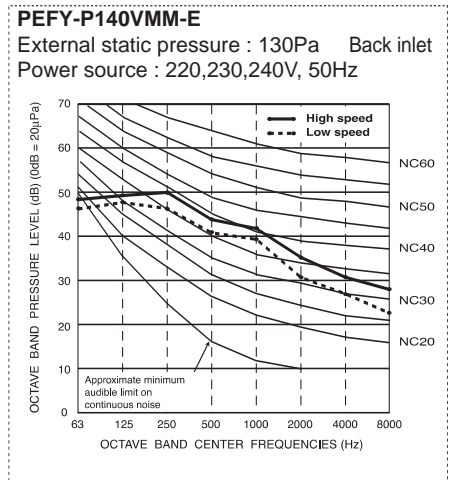
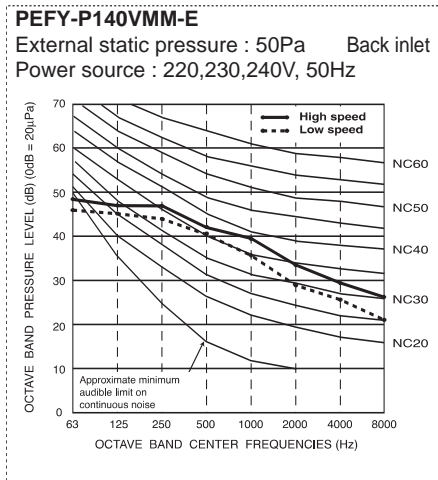
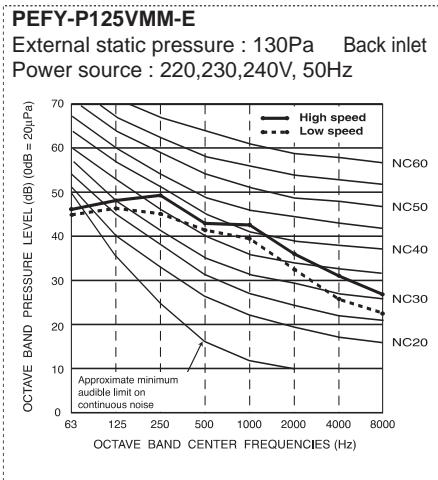
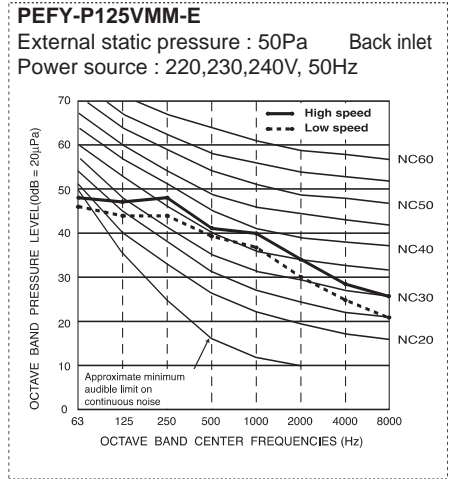
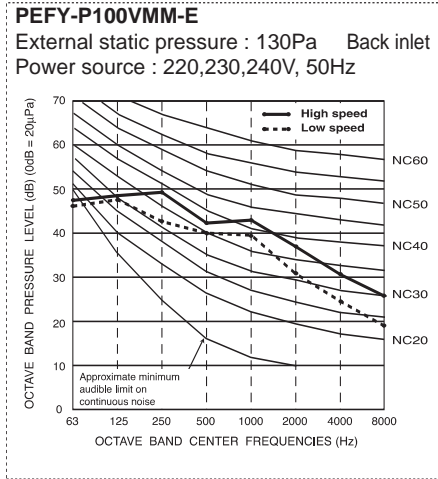
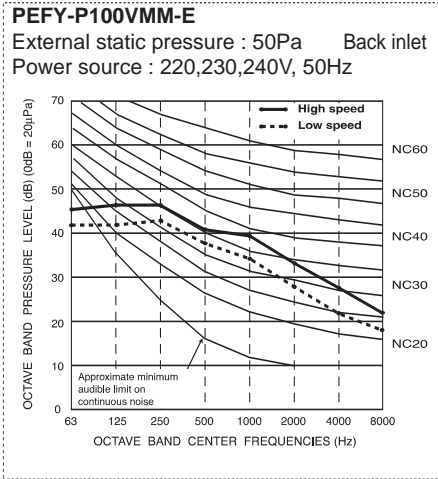

3-2. NC curves

PEFY-P40VMM-E
 External static pressure : 30Pa Bottom inlet
 Power source : 220,230,240V, 50Hz

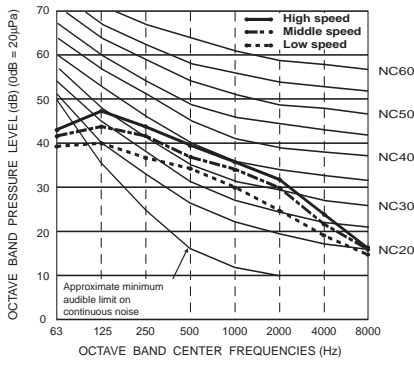

PEFY-P40VMM-E
 External static pressure : 50Pa Bottom inlet
 Power source : 220,230,240V, 50Hz

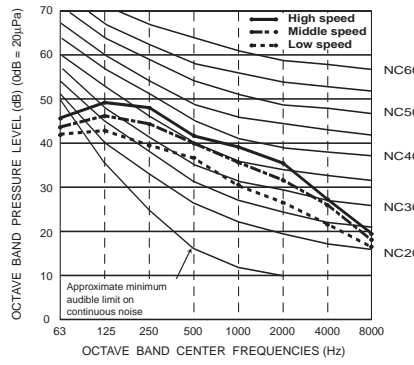

PEFY-P40VMM-E
 External static pressure : 100Pa Bottom inlet
 Power source : 220,230,240V, 50Hz

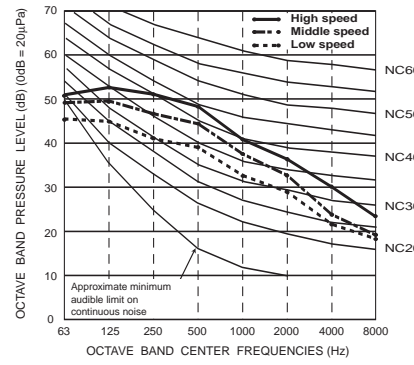

PEFY-P50VMM-E
 External static pressure : 30Pa Bottom inlet
 Power source : 220,230,240V, 50Hz

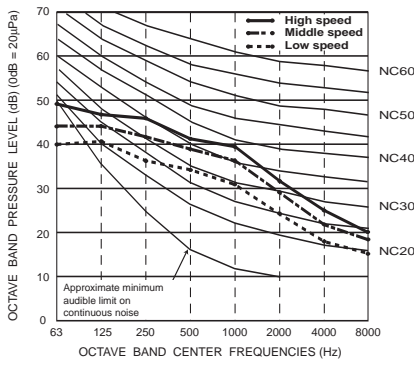

PEFY-P50VMM-E
 External static pressure : 50Pa Bottom inlet
 Power source : 220,230,240V, 50Hz

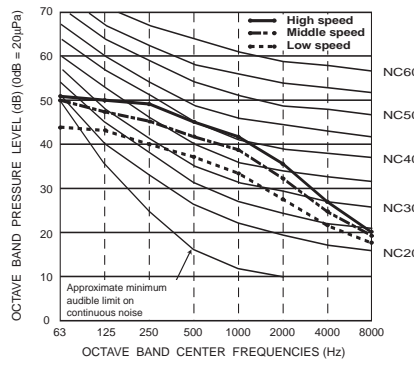

PEFY-P50VMM-E
 External static pressure : 100Pa Bottom inlet
 Power source : 220,230,240V, 50Hz

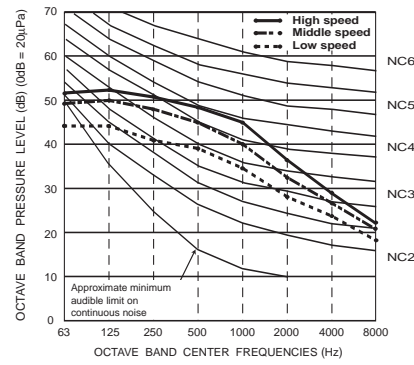

PEFY-P63VMM-E
 External static pressure : 30Pa Bottom inlet
 Power source : 220,230,240V, 50Hz

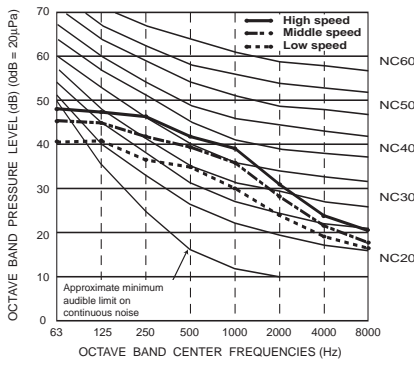

PEFY-P63VMM-E
 External static pressure : 50Pa Bottom inlet
 Power source : 220,230,240V, 50Hz

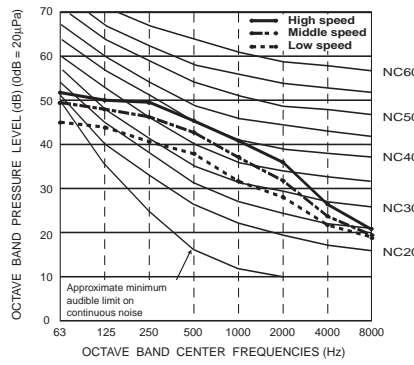

PEFY-P63VMM-E
 External static pressure : 100Pa Bottom inlet
 Power source : 220,230,240V, 50Hz

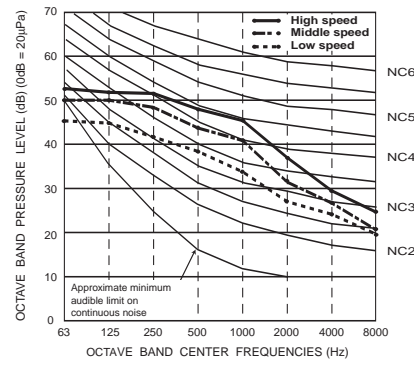

PEFY-P71,80VMM-E
 External static pressure : 30Pa Bottom inlet
 Power source : 220,230,240V, 50Hz

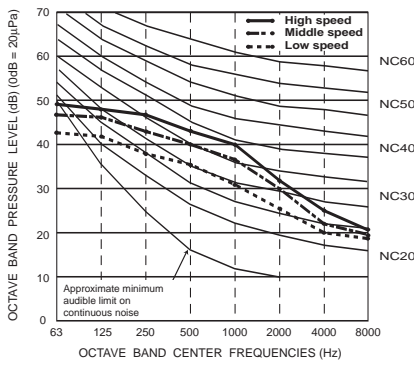

PEFY-P71,80VMM-E
 External static pressure : 50Pa Bottom inlet
 Power source : 220,230,240V, 50Hz

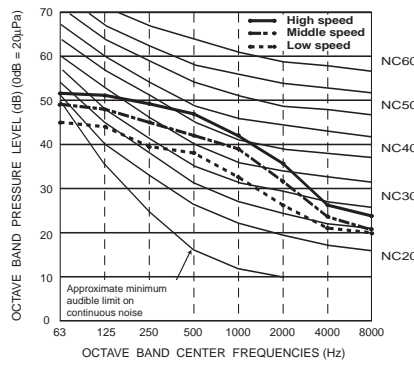

PEFY-P71,80VMM-E
 External static pressure : 100Pa Bottom inlet
 Power source : 220,230,240V, 50Hz

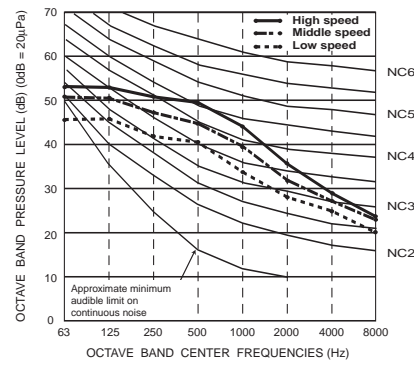

3-2. NC curves

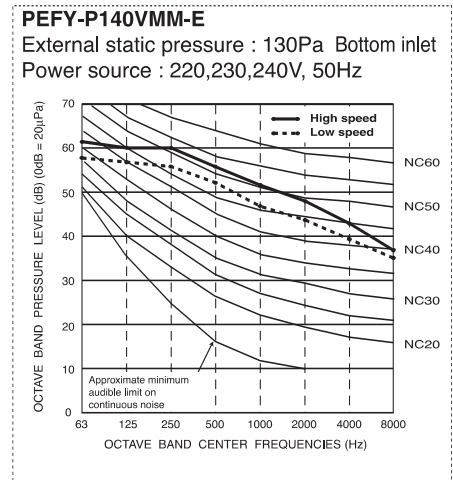
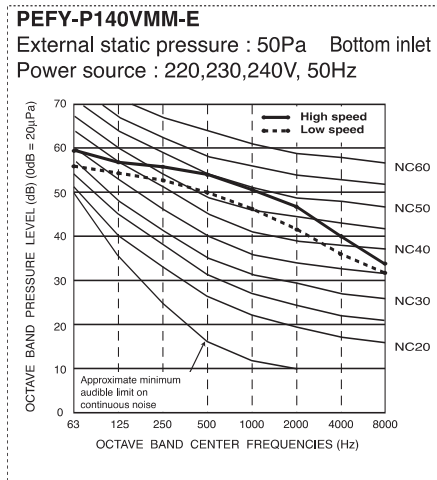
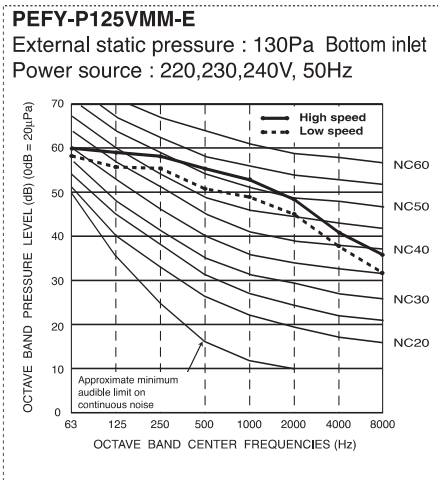
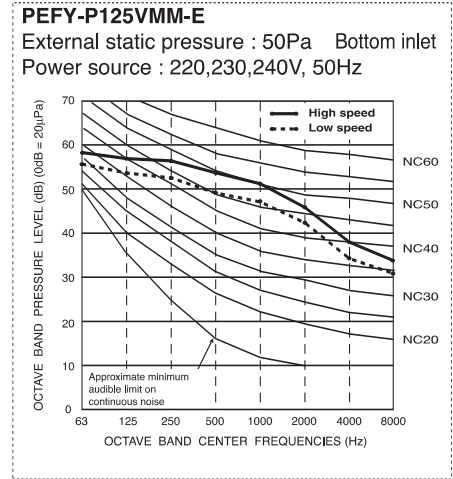
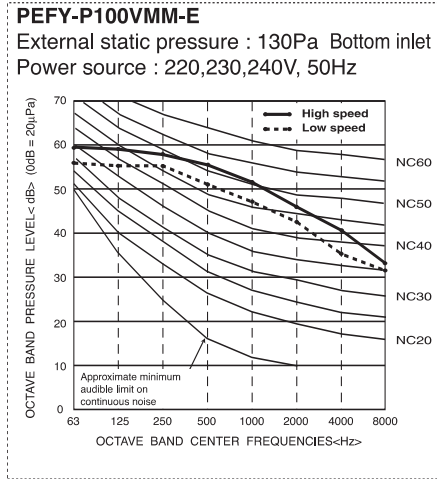
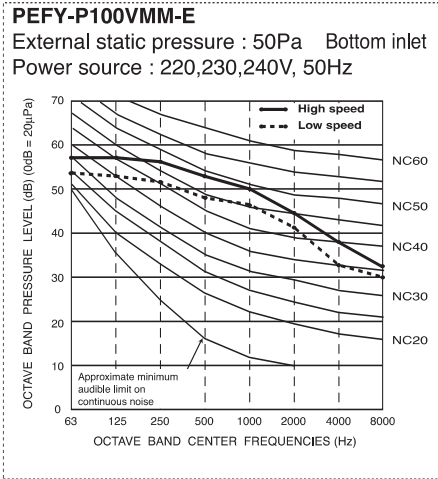

3. SOUND LEVELS

3-3. Fan characteristics curves

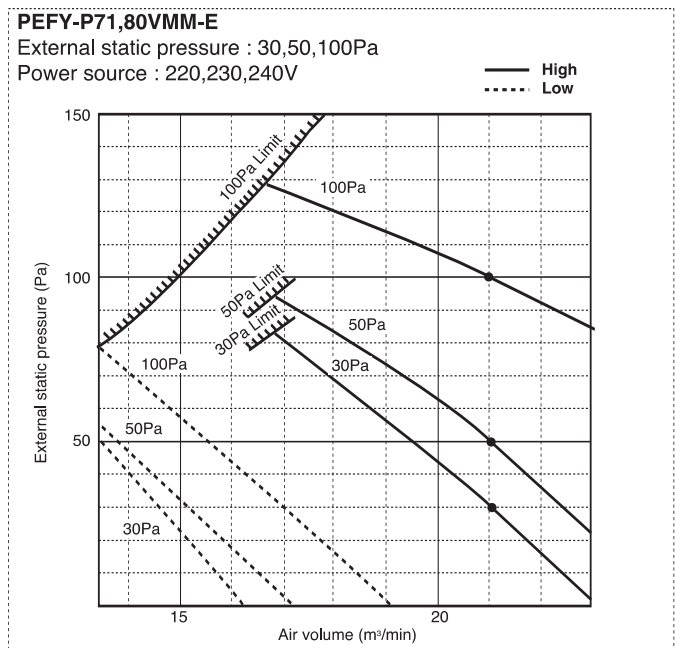
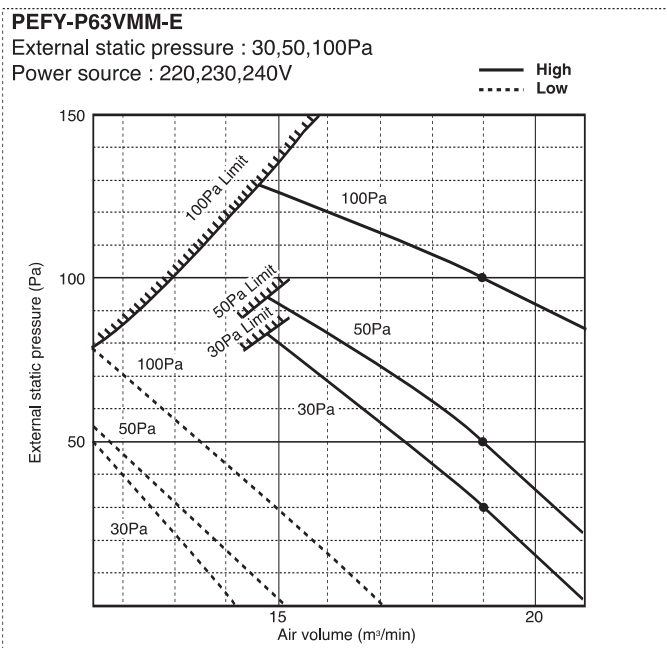
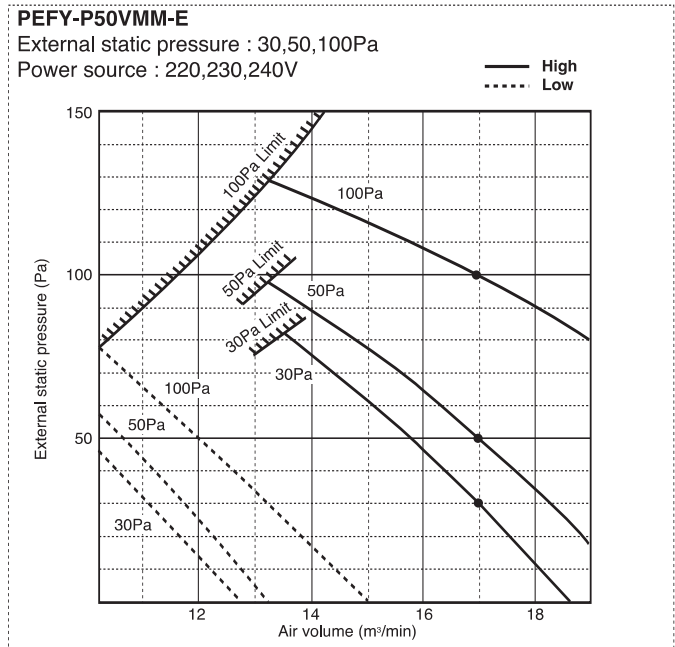
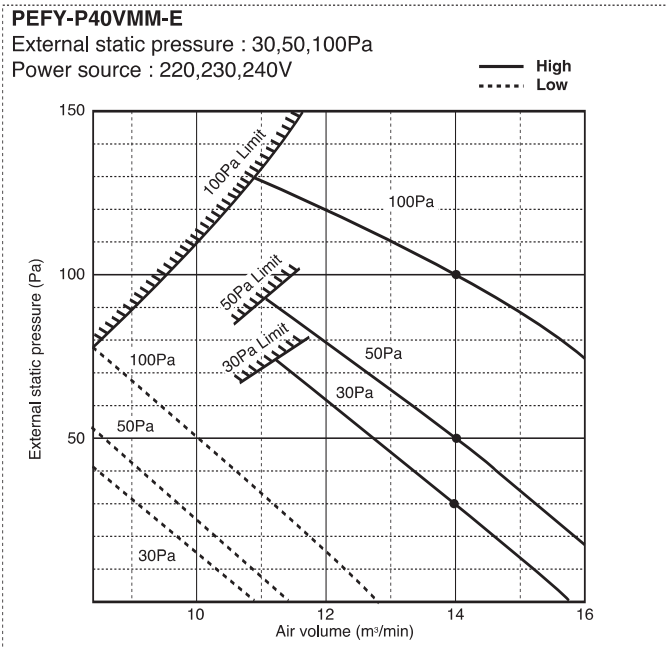
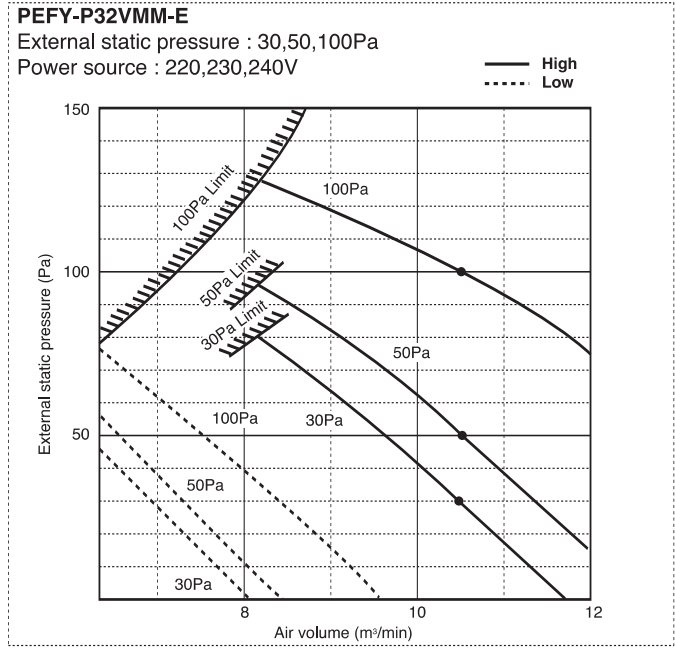
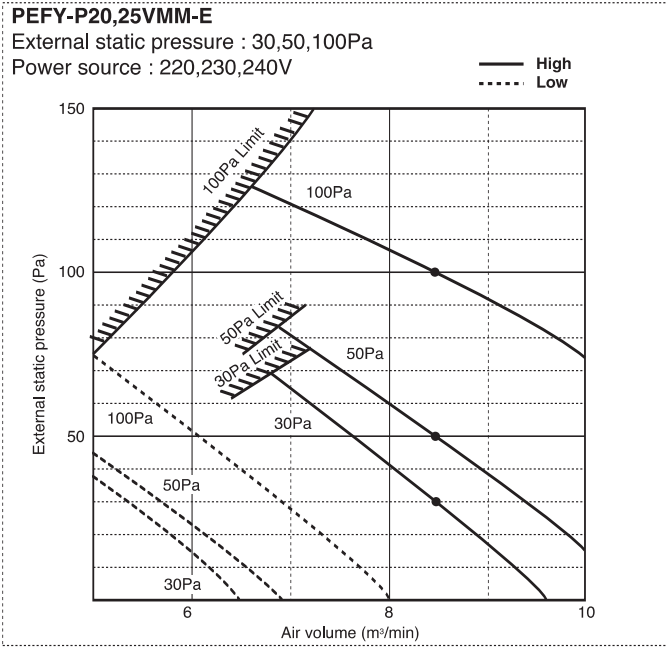

3. SOUND LEVELS

3-3. Fan characteristics curves

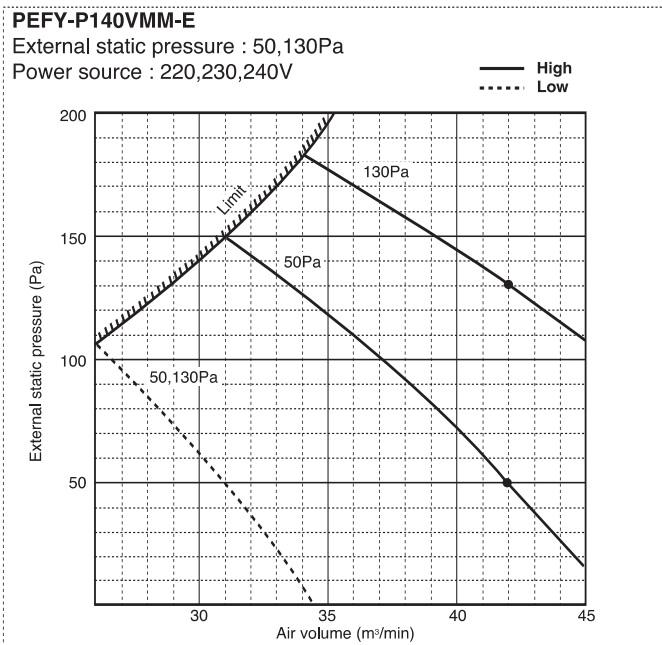
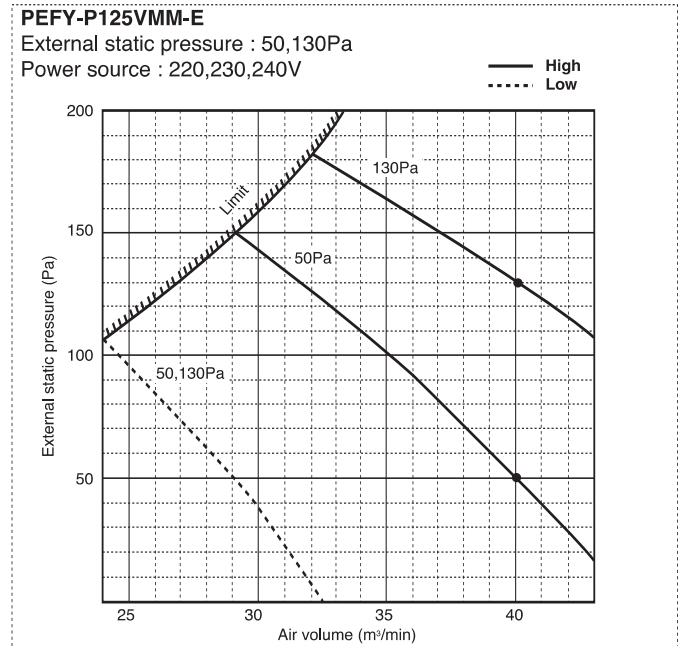
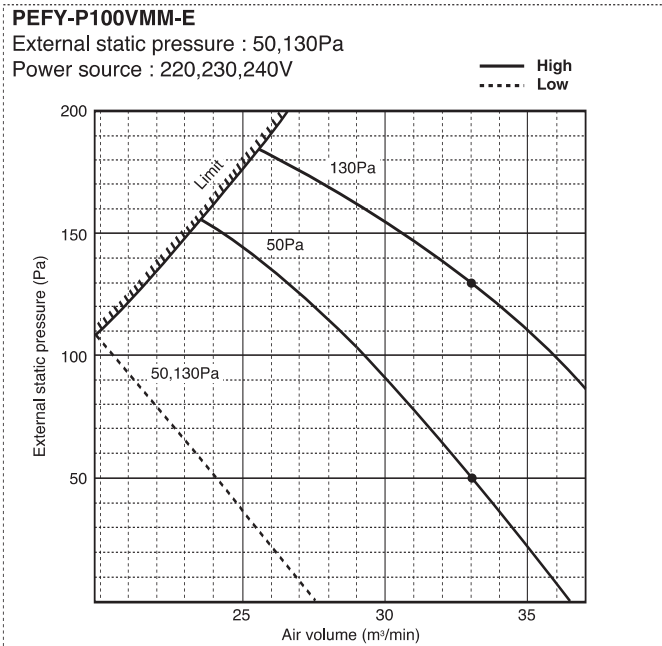

A
B
 C
 D
 E
 F
 G
 H
 I
 J
 V_a
 V_e
 BC

PEFY-P20,25,32,40,50,63,71,80VMM-E

Drw. : IU-W65-3948

Unit : mm

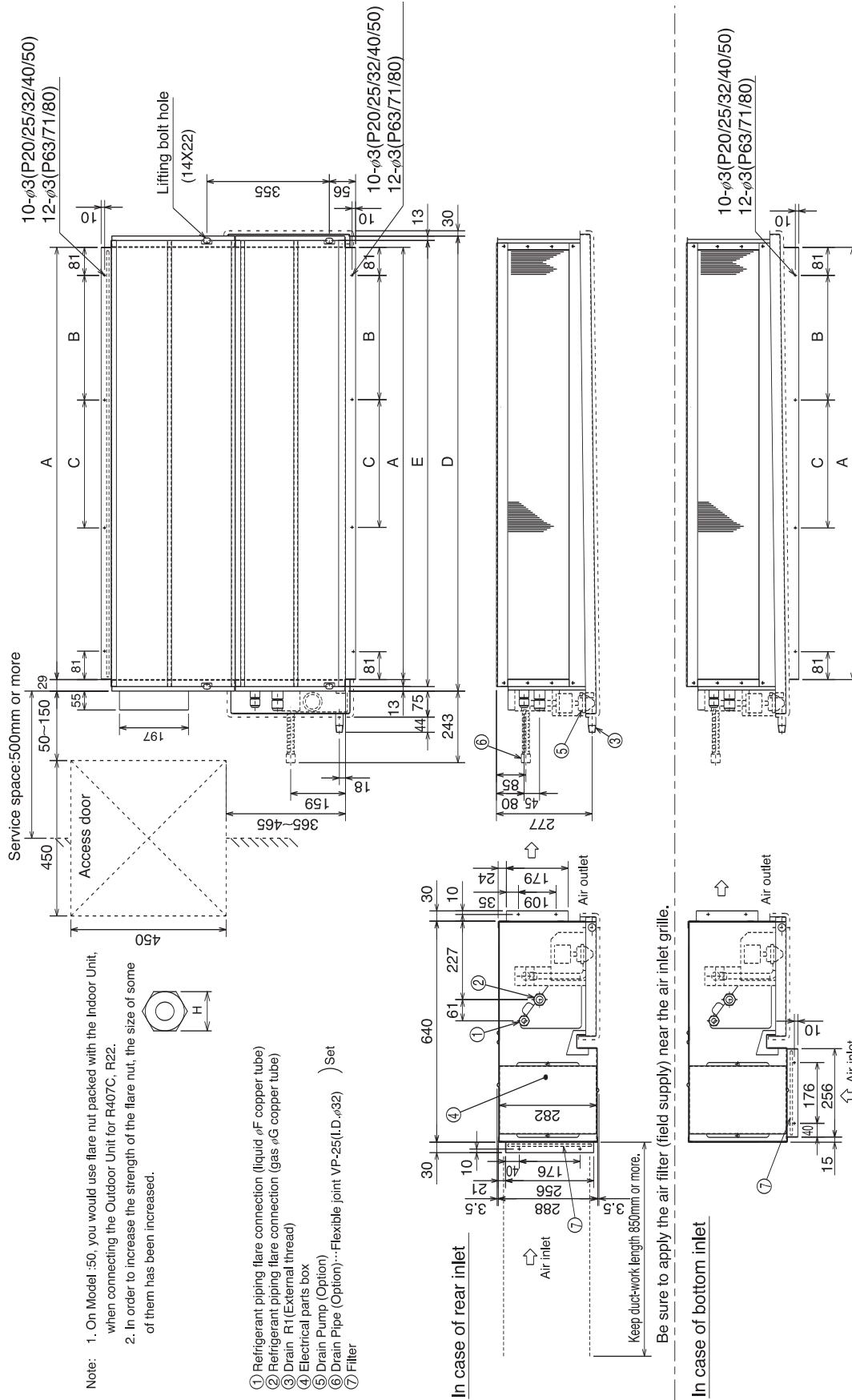

Note: 1. On Model :50, you would use flare nut packed with the Indoor Unit, when connecting the Outdoor Unit for R407C, R22.
2. In order to increase the strength of the flare nut, the size of some of them has been increased.

- ① Refrigerant piping flare connection (liquid φF copper tube)
- ② Refrigerant piping flare connection (gas φG copper tube)
- ③ Drain R1(External thread)
- ④ Electrical parts box
- ⑤ Drain Pump (Option)
- ⑥ Drain Pipe (Option)···Flexible joint VP-25(L.D.φ32) Set
- ⑦ Filter

In case of rear inlet

In case of bottom inlet

Model	A	B	C	D	E	F	G	H(Liquid)	H(Gas)
P20,25,32	652	245	-	710	684	6.35	12.7	17	27
P40	772	305	-	830	804	6.35	12.7	17	27
P50	772	305	-	830	804	*1	12.7	*1	*1
P63,71,80	1012	280	290	1070	1044	*2	9.52	*2	*2
							15.88		29
							15.88		29

*1:R410A outdoor unit
*2:R407C,R22 outdoor unit

PEFY-P100,125,140VMM-E

Drw. : IU-W65-3949
Unit : mm

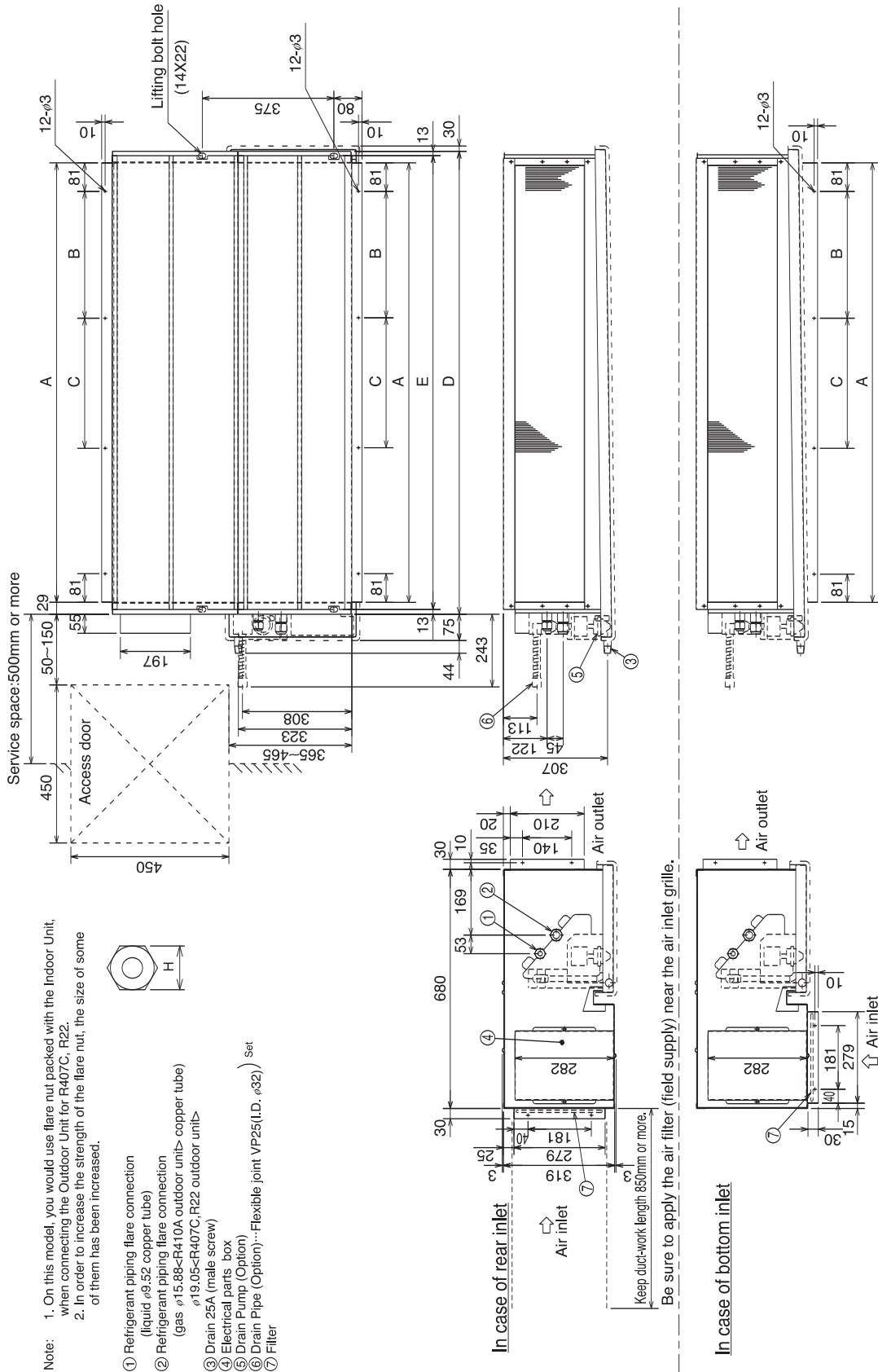

Note:

1. On this model, you would use flare nut packed with the Indoor Unit, when connecting the Outdoor Unit for R407C, R22.
2. In order to increase the strength of the flare nut, the size of some of them has been increased.



Model	A	B	C	D	E	F(Liquid)	F(Gas)
P100-125	1252	360	370	1310	1284	22	36
P140	1552	460	470	1610	1584	22	36

A
B
C
D
E
F
G
H
I
J
V_A
V_B
BC

4. EXTERNAL DIMENSIONS

R410A Data G2

PEFY-P20,25,32,40,50,63,71,80VMM-E with circular duct flange

Drw. : IU-W65-3948-1
Unit : mm

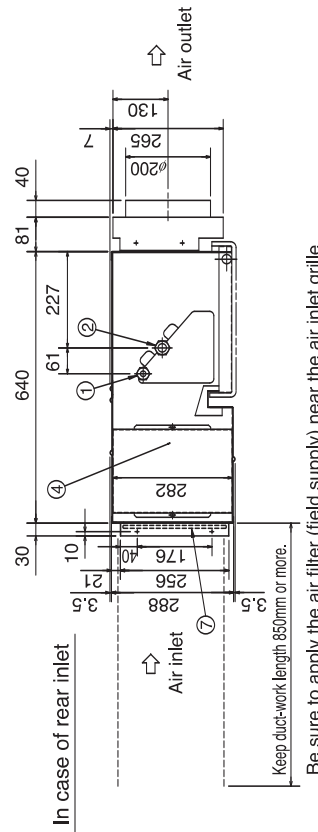
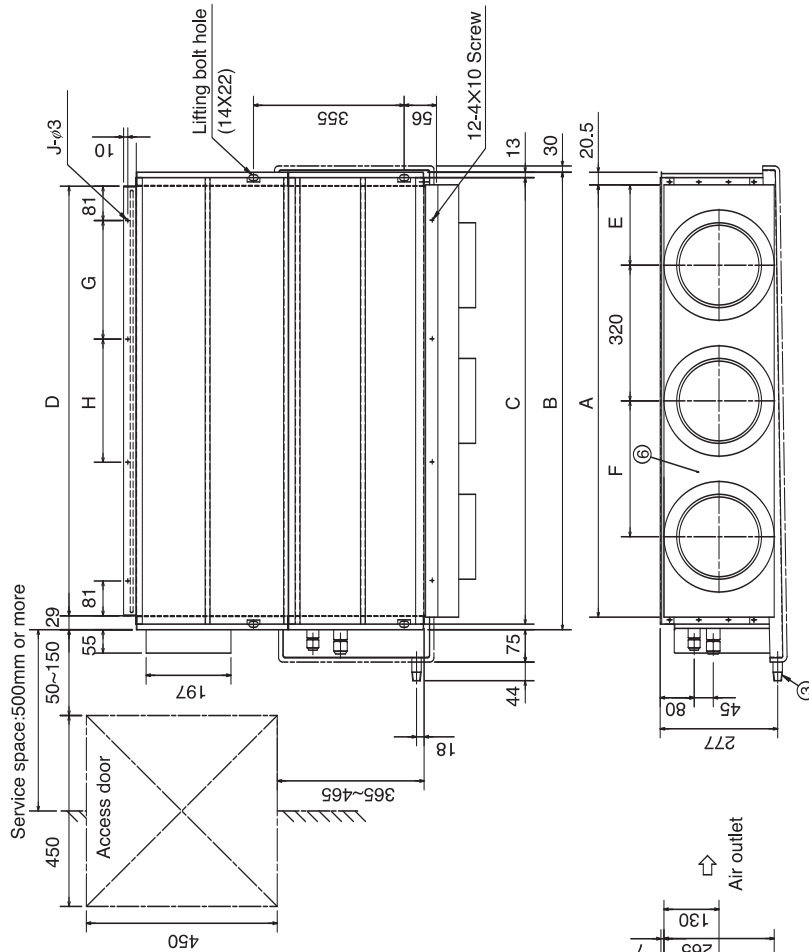

Model	A	B	C	D	E	F	G	H	J
P20,25,32	669	710	684	652	174.5	—	245	—	10
P40,50	789	830	804	772	234.5	—	305	—	10
P63,71,80	1029	1070	1044	1012	194.5	320	280	290	12

- 1 Refrigerant piping flare connection (liquid ϕ K copper tube)
- 2 Refrigerant piping flare connection (gas ϕ L copper tube)
- 3 Drain R1 (External thread)
- 4 Electrical parts box
- 5 Filter
- 6 Circular duct flange (Option)

Model	K	L
P20,25,32	6.35	12.7
P40,50	6.35	12.7
P63,71,80	9.52	15.88

4. EXTERNAL DIMENSIONS

PEFY-P100,125VMM-E with circular duct flange

Drw. : IU-W65-3949-1
Unit : mm

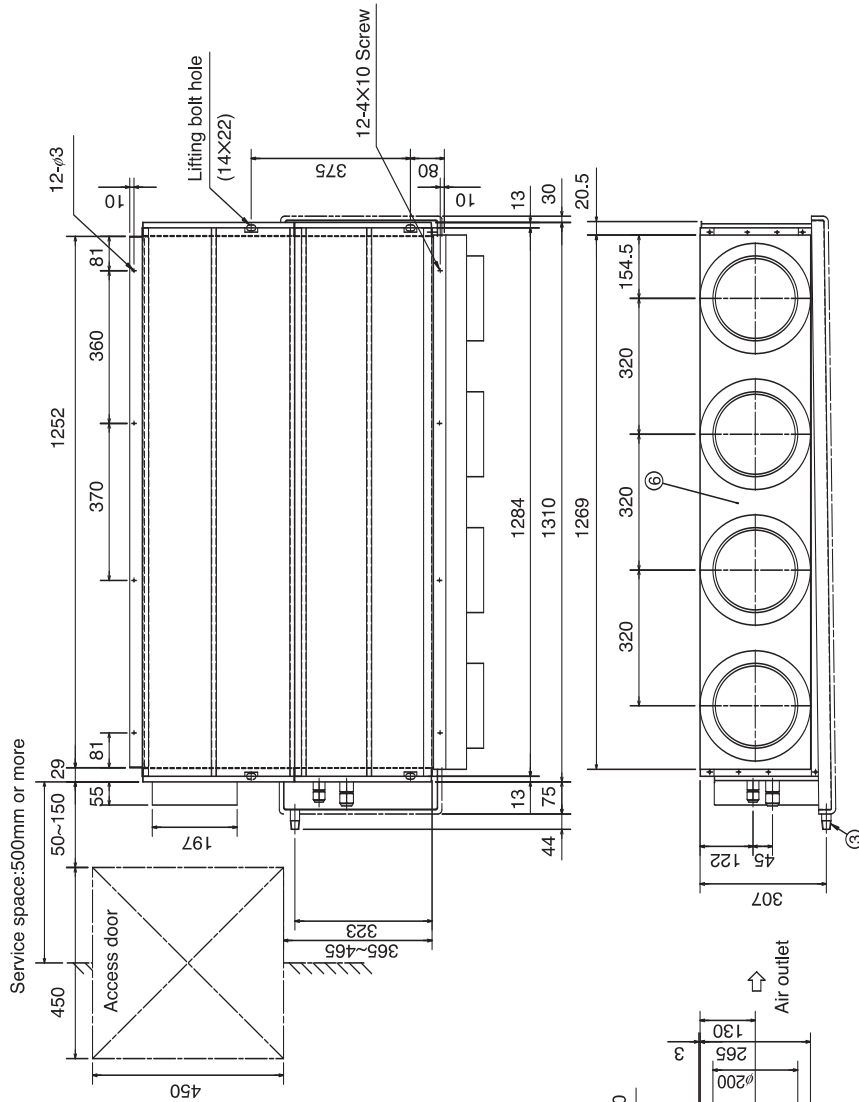

Service space: 500mm or more

- 1 Refrigerant piping flare connection (liquid ϕ 9.52 copper tube)
- 2 Refrigerant piping flare connection (gas ϕ 15.88 copper tube)
- 3 Drain 25A (External thread)
- 4 Electrical parts box
- 5 Filter
- 6 Circular duct flange (Option)

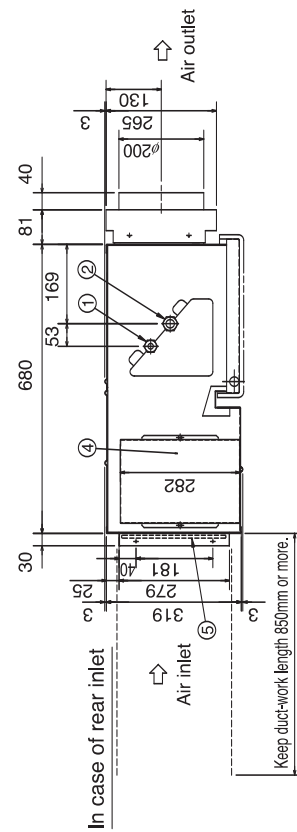

Be sure to apply the air filter (field supply) near the air inlet grille.

PEFY-P140VMM-E with circular duct flange

Draw. : IU-W65-3949-2
Unit : mm

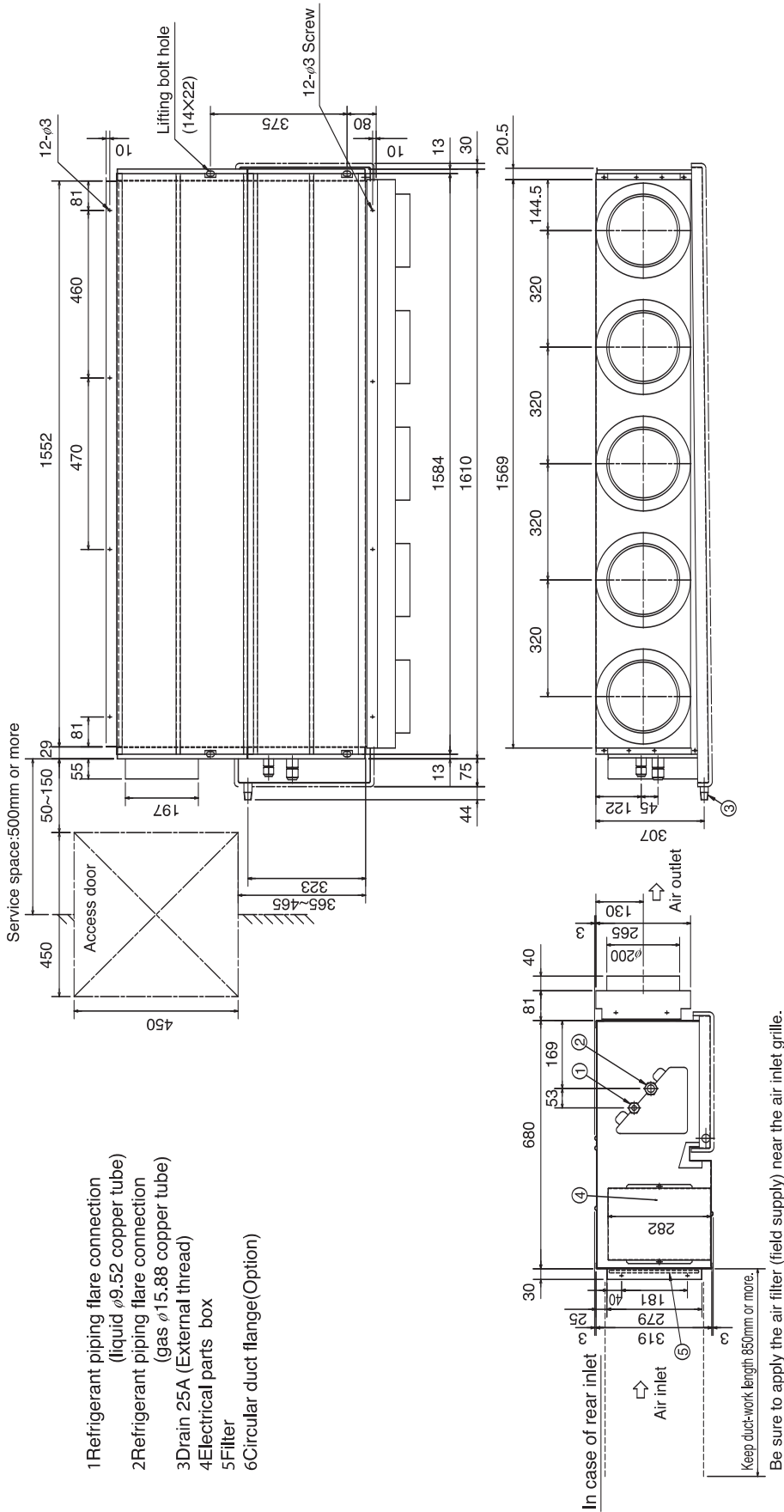

PEFY-P20,25,32,40,50,63,71,80VMM-E

Draw. : IU-W65-3958

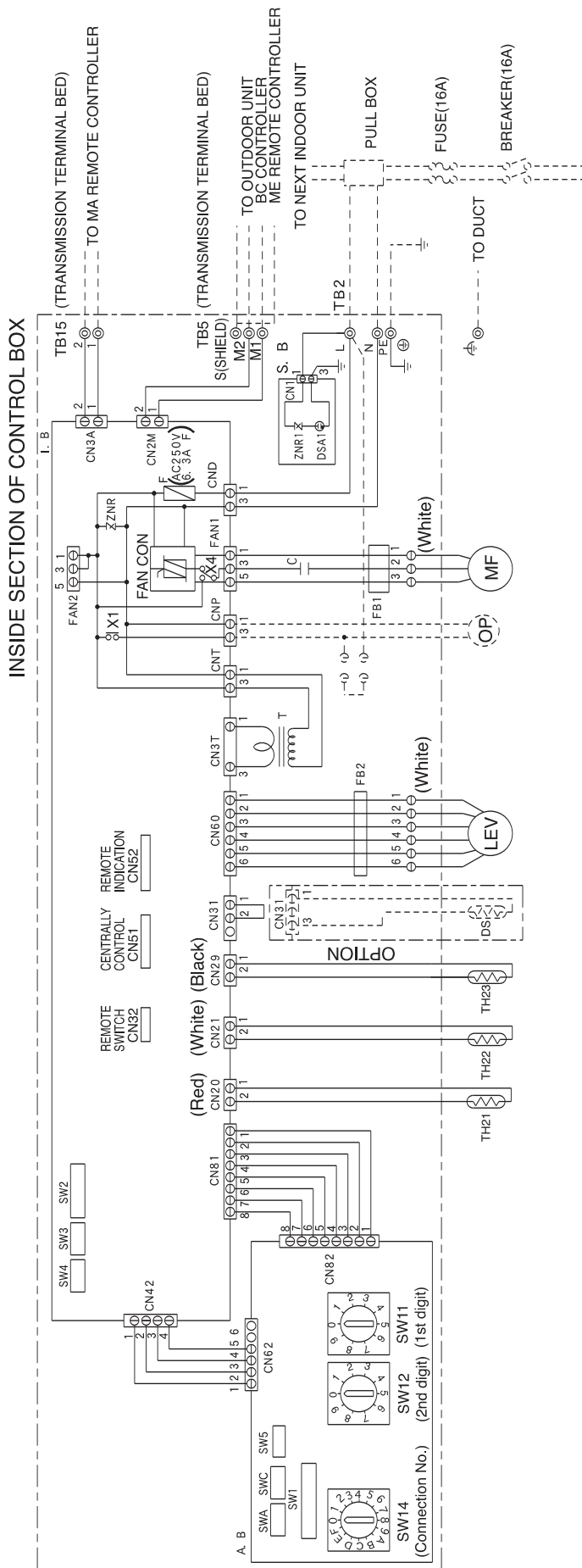

POWER SUPPLY
~IN 220-240V 50Hz

NOTE: 1. TB2, TB5 shown in dotted line are field work.
2. Mark (C) indicates terminal bed, (S) connector, (I) board insertion connector or fastening connector of control board.
*Capacitor
MODELS 20/25/32 6.4F
MODELS 40/50 6.4F
MODELS 63/71/80 6.4F

SYMBOL EXPLANATION

SYMBOL	NAME	SYMBOL	NAME
MF	Fan motor	SWA (AB)	Switch (option parts)
C	*Capacitor (for MF)	SWC (AB)	Switch (option parts)
IB	Indoor controller board	SW11 (AB)	Switch (1st digit address set)
AB	Address board	SW12 (AB)	Switch (2nd digit address set)
TB2	Power source terminal bed	SW14 (AB)	Switch (connection No.set)
TB5	Transmission terminal bed	SW1 (AB)	Switch (for mode selection)
TB15	Transmission terminal bed	SW2 (LB)	Switch (for capacity code)
F	Fuse AC250V 6.3AF	SW3 (LB)	Switch (for model selection)
T	Transformer	SW4 (LB)	Switch (for model selection)
LEV	Electronic linear expansion valve	SW5 (AB)	Switch (for voltage selection)
TH21	Thermistor (inlet temp.detection)	FB1,2	Ferrite core
TH22	Thermistor (piping temp.detection/liquid)	SB	Surge absorber board
TH23	Thermistor (piping temp.detection/gas)	DP	Drainpump
		DS	Drainsensor

PEFY-P100,125,140VMM-E

Drw. : IU-W65-3959

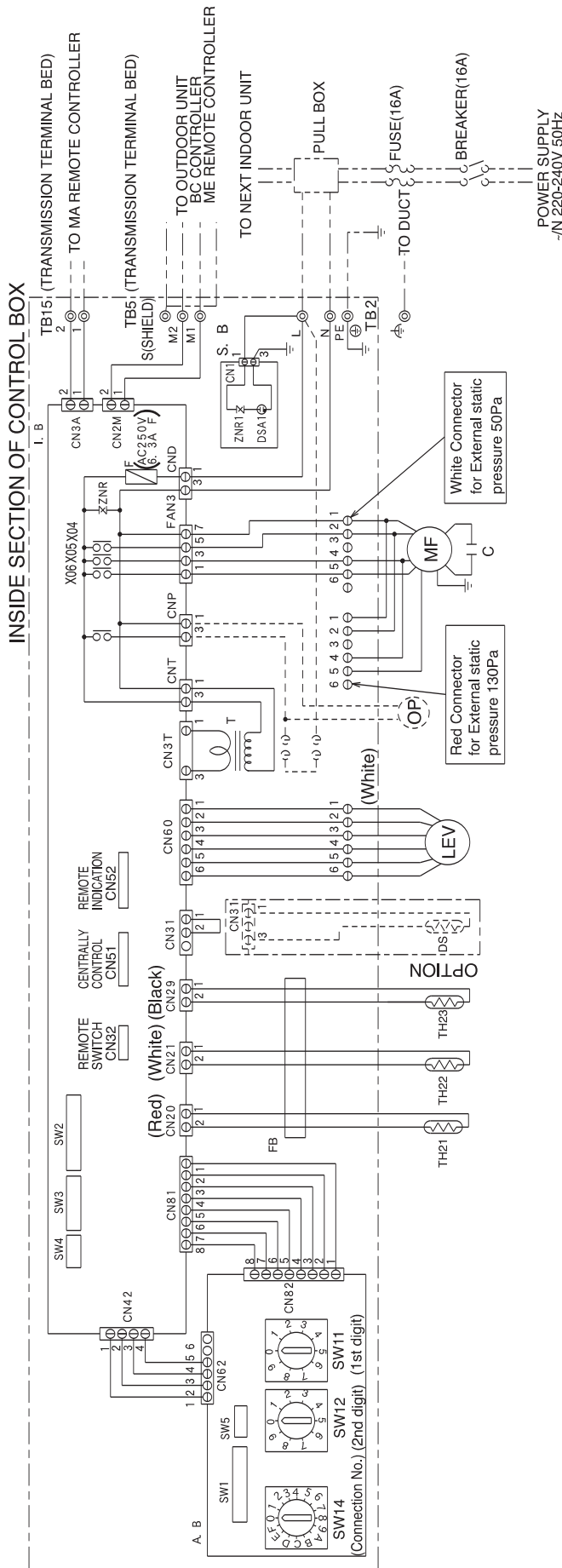

NOTE:1. TB2, TB5 shown in dotted line are field work.
 2. Mark ⊙ indicates terminal bed, ⊕ connector, ⊞ board insertion connector or fastening connector of control board.

※Capacitor
 MODELS 100/125/140 84F

SYMBOL EXPLANATION

SYMBOL	NAME	SYMBOL	NAME
MF	Fan motor	TH22	Thermistor (piping temp.detection/liquid)
C	Capacitor (for MF)	TH23	Thermistor (piping temp.detection/gas)
I.B	Indoor controller board	SW11 (A.B)	Switch (1st digit address set)
AB	Address board	SW12 (A.B)	Switch (2nd digit address set)
TB2	Power source terminal bed	SW14 (A.B)	Switch (connection No.set)
TB15	Transmission terminal bed	SW1 (A.B)	Switch(for mode selection)
TB5	Transmission terminal bed	SW2 (I.B)	Switch(for capacity code)
F	Fuse AC250V 6.3A F	SW3 (I.B)	Switch(for mode selection)
T	Transformer	SW4 (I.B)	Switch(for model selection)
LEV	Electronic linear expan. valve	SW5 (A.B)	Switch(for voltage selection)
S.B	Surge absorber board	X04~06	Aux. relay
FB	Ferrite core	DP	Drainpump
TH21	Thermistor (inlet temp.detection)	DS	Drainsensor

Description	Model	Applicable capacity
Circular duct flange	PAC-KE32EDF-F	PEFY-P20,25,32VMM-E
	PAC-KE50EDF-F	PEFY-P40,50VMM-E
	PAC-KE80EDF-F	PEFY-P63,71,80VMM-E
	PAC-KE125EDF-F	PEFY-P100,125VMM-E
	PAC-KE140EDF-F	PEFY-P140VMM-E
Drain pump kit	PAC-KE03DM-F	PEFY-P20,25,32,40,50,63,71VMM-E PEFY-P80,100,125,140VMM-E

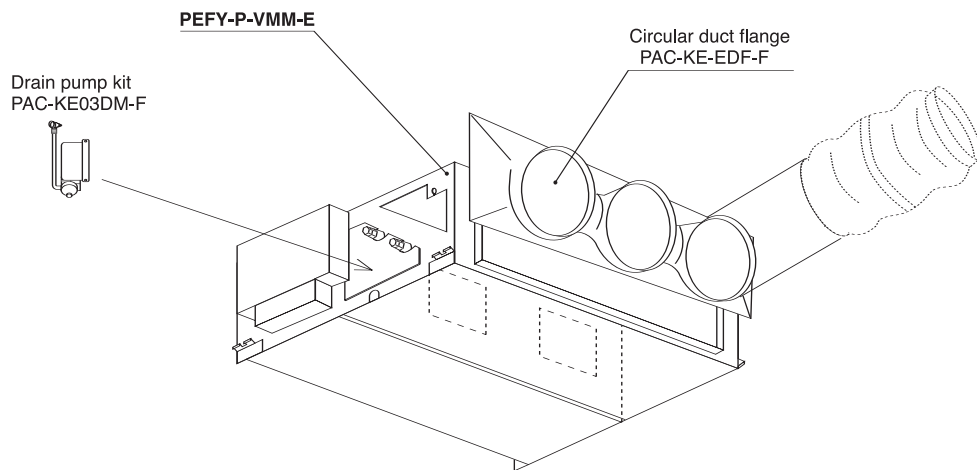

- A
- B**
- C
- D
- E
- F
- G
- H
- I
- J
- V_a
- V_b
- BC

- A
- B**
- C
- D
- E
- F
- G
- H
- I
- J
- V_a
- V_b
- BC